

TALLY MICHAEL ANASTASSIADES



Mutina



TALLY

MICHAEL ANASTASSIADES

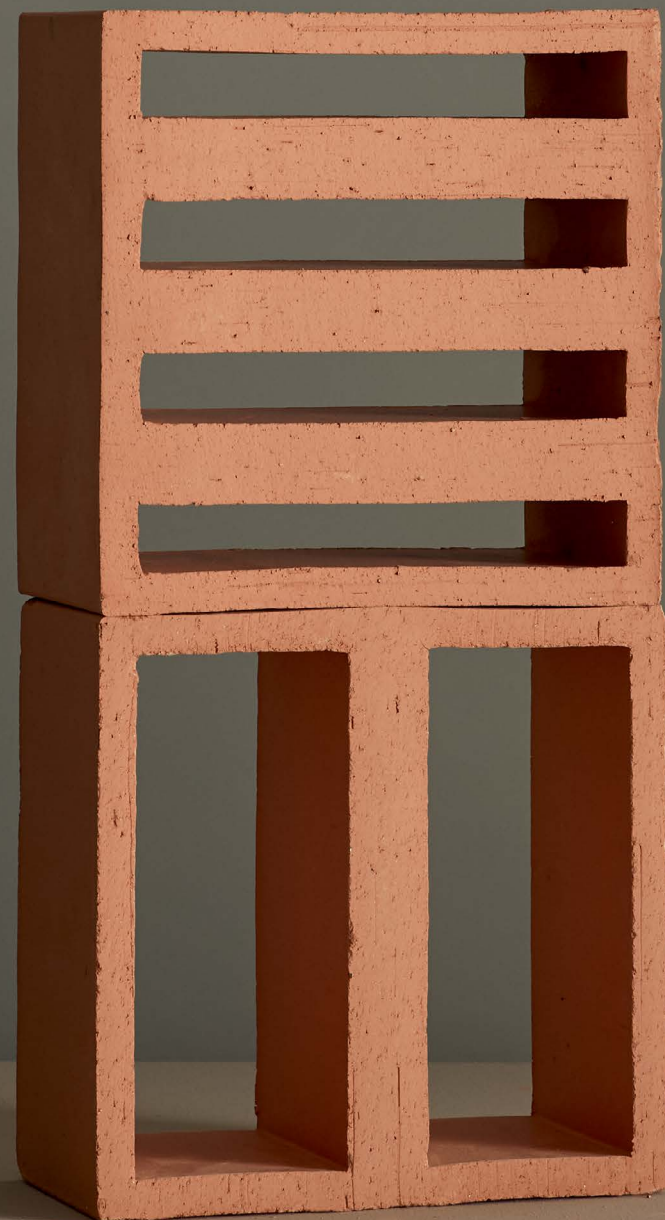

Tally è un mattone in terracotta ottenuto dall'estrusione di un quadrato suddiviso in sezioni longitudinali. Ideato da Michael Anastassiades, nasce come una reinterpretazione tridimensionale di Fringe – la prima collezione ceramica realizzata dal designer per Mutina. I singoli componenti possono essere assemblati in orizzontale, in verticale o in una combinazione di entrambi, generando un'infinita serie di configurazioni uniche.

Il nome deriva dai "Tally marks", un sistema di calcolo che utilizza unità di quattro linee verticali barrate da una quinta diagonale. Analogamente, Tally aggiunge gruppi predefiniti di linee per creare un'unica disposizione, che può essere estesa in qualsiasi direzione e secondo qualsiasi configurazione.

La collezione si compone di due diversi mattoni – uno diviso in due da una singola linea al centro (Wide), e l'altro diviso in quattro (Narrow). La cornice esterna di ciascun pezzo è spessa la metà delle linee che lo dividono. Grazie a questa semplice considerazione geometrica, i mattoni possono essere disposti in modo da creare uno schema che si ripete all'infinito, con una spaziatura sempre costante.

Tally is a terracotta brick created by extruding a square divided into longitudinal sections. Designed by Michael Anastassiades, it is conceived as a three-dimensional reinterpretation of Fringe—the first ceramic collection that he made for Mutina. The individual components can be assembled horizontally, vertically, or in a combination of both, generating an infinite series of unique configurations.

The name derives from "Tally marks," a counting system that uses groups of four vertical lines crossed by a fifth diagonal line. Similarly, Tally adds predefined groups of lines to create a single arrangement, which can be extended in any direction and configuration.

The collection consists of two different bricks—one divided in two by a single line at the centre (Wide), and the other divided into four (Narrow). The outer frame of each piece is half the thickness of the lines that divide it. Thanks to this simple geometric consideration, the bricks can be arranged to create a pattern that repeats infinitely with consistent spacing.



“TALLY HA LA CAPACITÀ DI DIVENTARE UN CODICE, QUASI UNA SCRITTURA, NEL MODO IN CUI VIENE UTILIZZATO. E IN UN CERTO SENSO È ESATTAMENTE QUELLO CHE È: UN ALFABETO NUMERICO CON UNA DIMENSIONE VISIVA.”

“TALLY HAS THE CAPACITY TO BECOME A CODE, ALMOST A SCRIPT, IN THE WAY IT IS USED. AND IN A SENSE, THAT’S EXACTLY WHAT IT IS: A NUMERICAL ALPHABET WITH A VISUAL DIMENSION.”

MICHAEL ANASTASSIADES

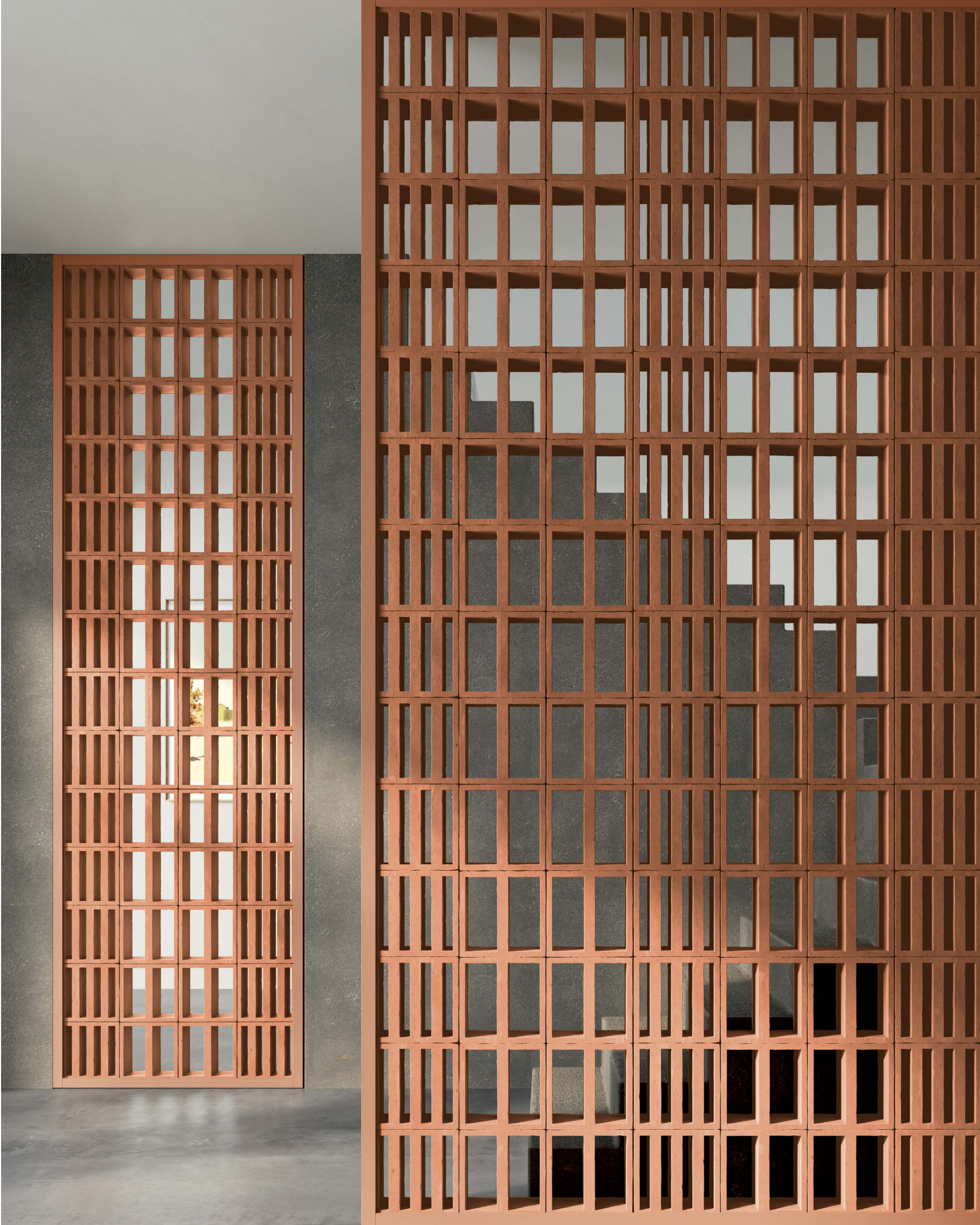

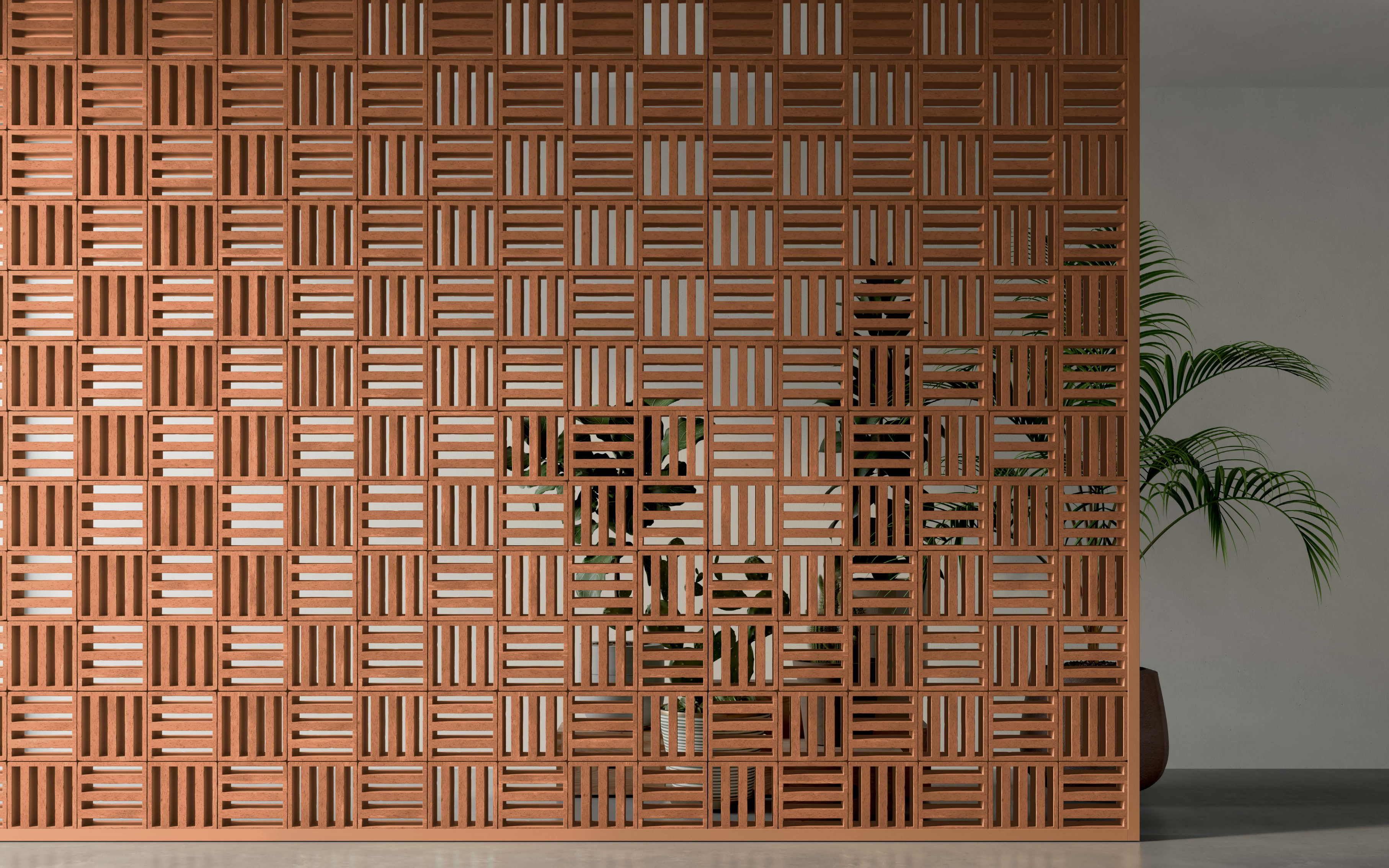

Technical Features

collection	Tally
design	Michael Anastassiades, 2024
production	Artisanal
material	Extruded terracotta
thickness	10 cm
nominal sizes	24x24x10 cm
specification	<p>artisanal extruded partition elements, 10cm thick. 2 models 1 colours: Natural (natural finishing)</p> <p>This product is suitable for both residential and commercial areas, to be installed in walls with height of 4mt. These elements must in any case comply with the technical standards of construction regulation, applicable in the country where they are installed. For the Italian national territory, in particular, they should comply with standard NTC 2018 DECRETO MIN 27/01. In order to achieve an optimal aesthetic outcome we advise to install TALLY using our wooden profile. A top profile with removable sides is provided for ceiling fixing. As complementary pieces Mutina provide the Mutina adhesive, EC 1 plus for VOC emissions.</p>
category	UNI 11128/2004

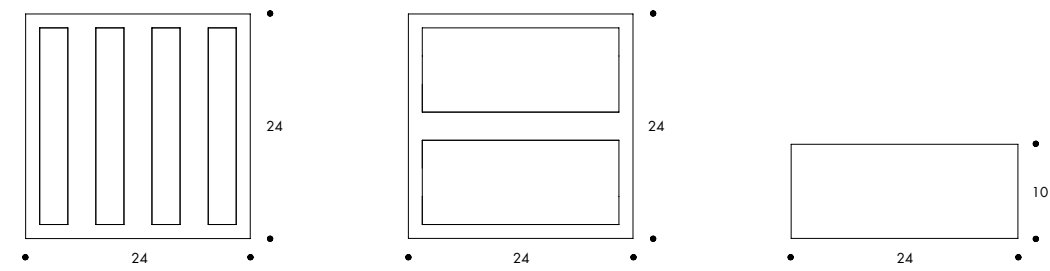

complementary pieces

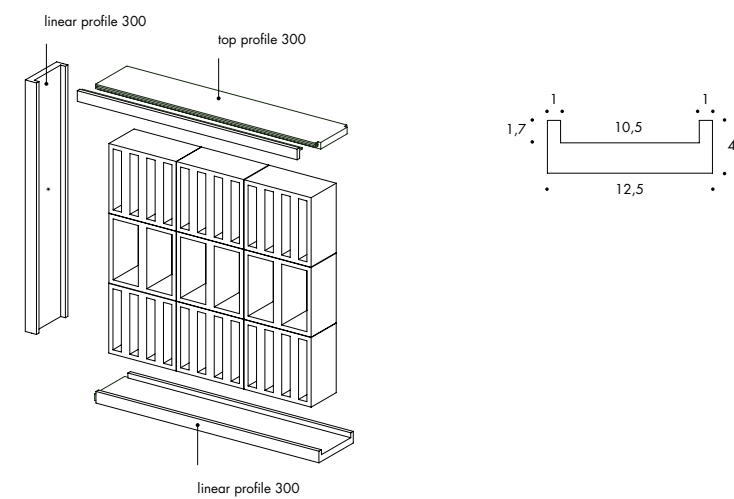

laying scheme

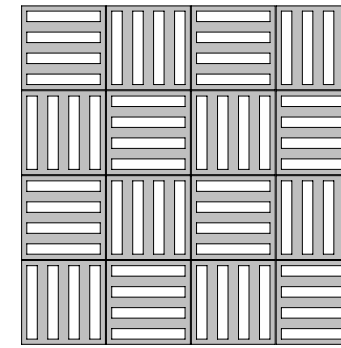

laying scheme 1

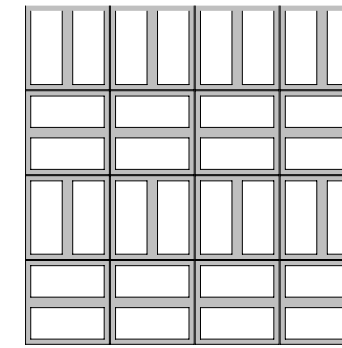

laying scheme 2

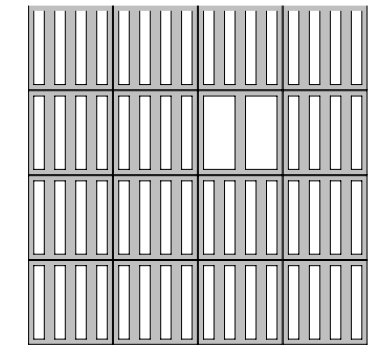

laying scheme 3

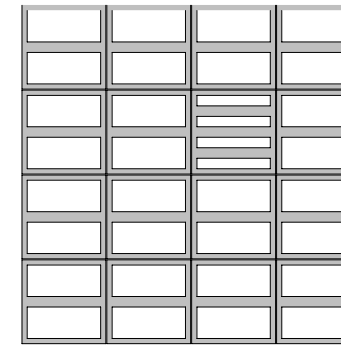

laying scheme 4

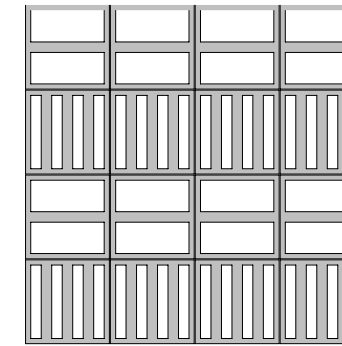

laying scheme 5

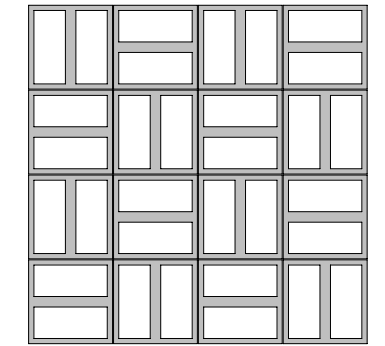

laying scheme 6

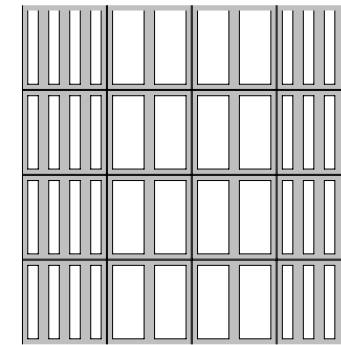

laying scheme 7

ANCHORING ON 2 SIDES MAX h400 cm

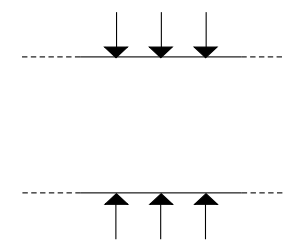

ANCHORING ON 3 SIDES MAX h400x300 cm

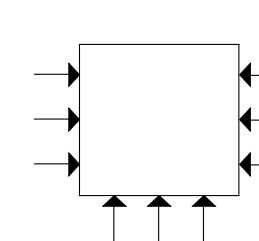

ANCHORING ON 2 SIDES MAX h250x100 cm

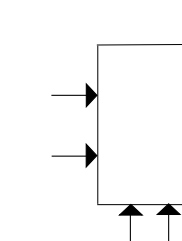

Laying and maintenance tips

use	Tally is suitable for indoor and outdoor areas complying with UNI EN 772:22 marked "F1- moderate exposure".
installation	-
recommended adhesive	Mutina adhesive: solvents-free, eco-friendly organic adhesive.
recommended joints	-
recommended fillers	-
cleaning at the end of installation	Avoid drippings during installation. If needed the excess can be removed after the product has dried, using a tool with a sharp edge.
general cleaning (installed tiles)	-
calibers (real size)	24 x 24 x 10 cm with 1-3 mm tolerance (artisanal product)

Colours



Tally Wide



Tally Narrow

Technical features

STANDARD	FEATURES	VALUE REQUIRED	TALLY
UNI EN 772-16	dimensions	to declare	T2-R2
UNI EN 772-21	water absorption	to declare	12,5%
UNI EN 772-5	soluble salts content	to declare	S2
UNI EN 772-22	freeze-thaw resistance	to declare	F1
D.M. 1401/2008	determination of variable horizontal loads	to declare	C2
Leed 4.1			10%
VOC Emission			available upon request
Declaration of Contents			available upon request
SDS			available upon request
BPD3			available upon request
HPD			available upon request

Packing

SIZE	PCS-SQM	SQM-PAL	PCS-PAL	KG-PC	KG-PAL
Tally Narrow	17,36	1,84	32	6,50	208
Tally Wide	17,36	1,84	32	3,80	121,60

Mutina

