



SpecCeramics

A&D Hard Surface Choice

100% Employee Owned

30 Flavors

A collection of 30 different SKU's that are stocked in a 3rd party warehouse, ready to go for your next project.



Circular Collection

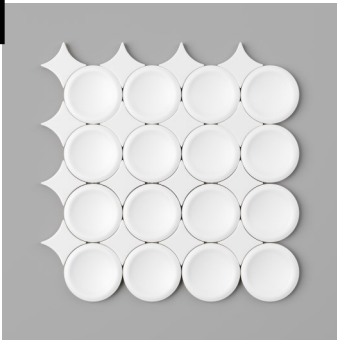

White



Taupe

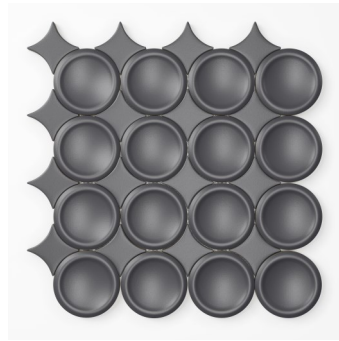

Dark Grey



Black

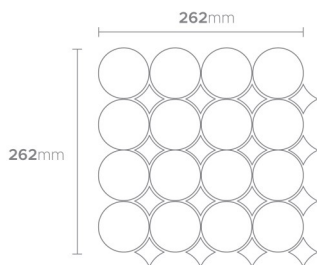
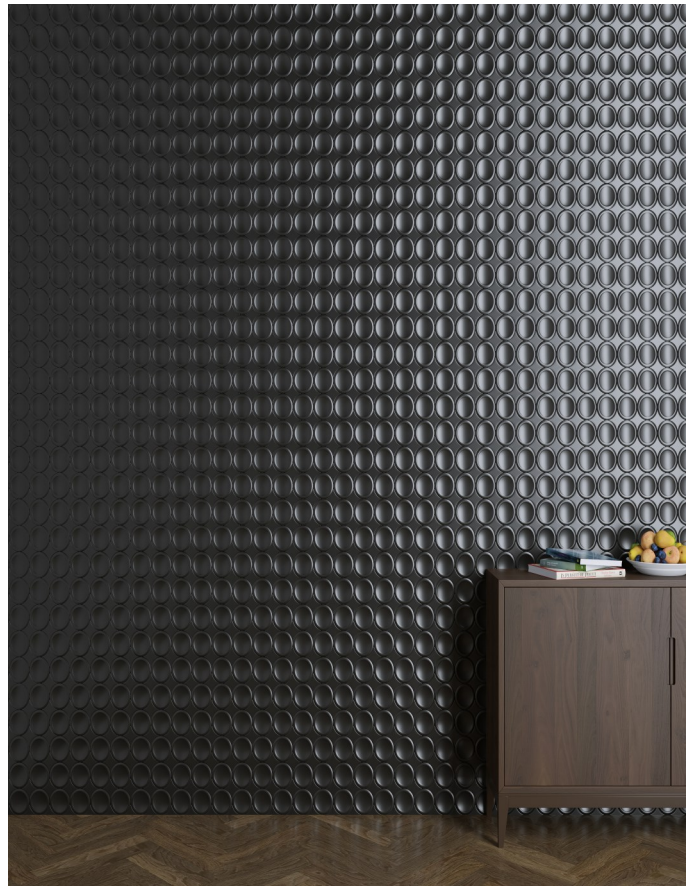

SIZE: 10.315" x 10.315"
MATERIAL TYPE: Ceramic
SURFACE FINISH: Matte

Geometrica Collection



Taupe

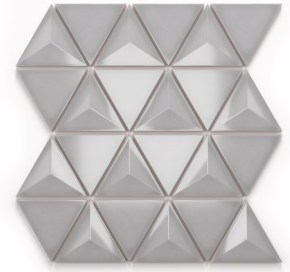

Light Grey

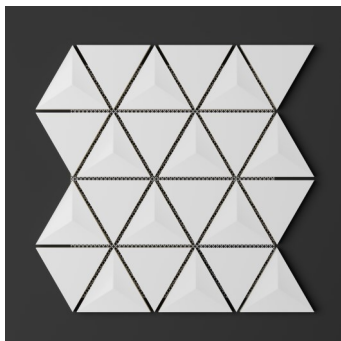

White

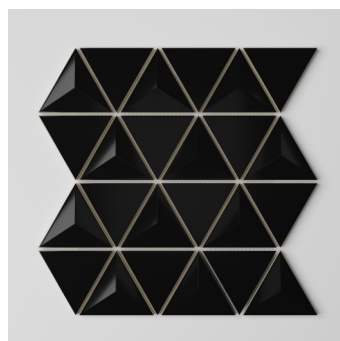

Black

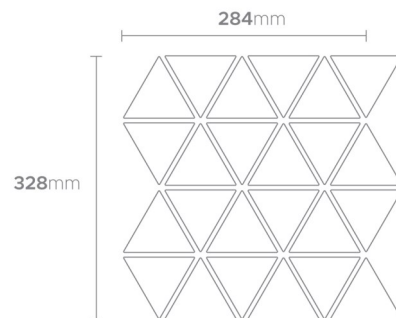

SIZE: 11.18" x 12.91"

MATERIAL TYPE: Ceramic

SURFACE FINISH: Glossy

Cube Collection



Sage

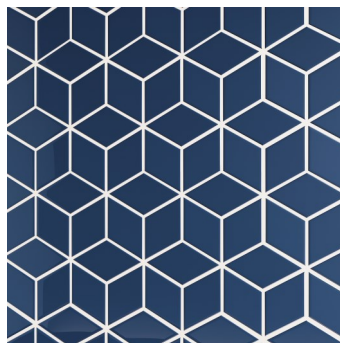

Ocean Blue

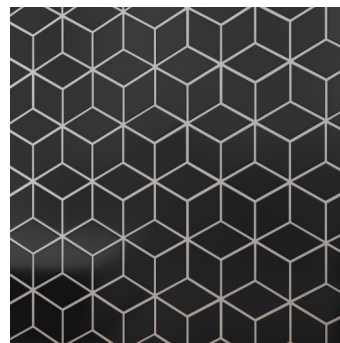

Black



White

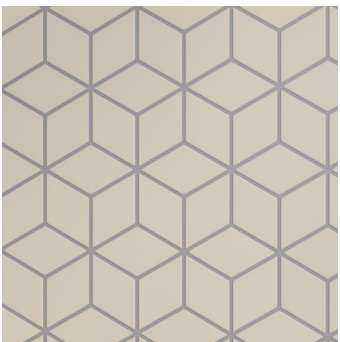

Taupe

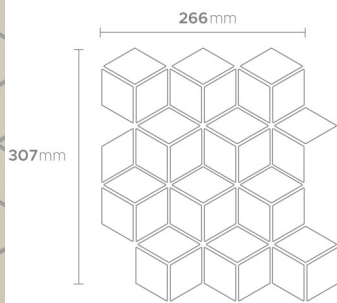

SIZE: 10.47" x 12.08"

MATERIAL TYPE: Porcelain

SURFACE FINISH: Gloss

Vienna Collection

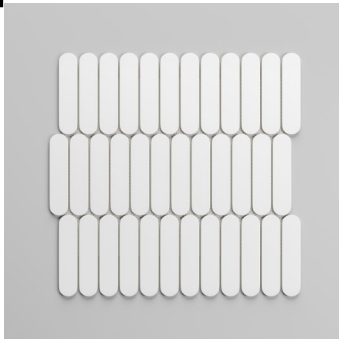

White

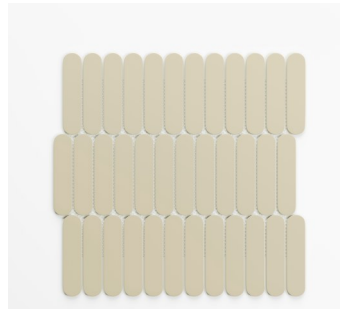

Taupe

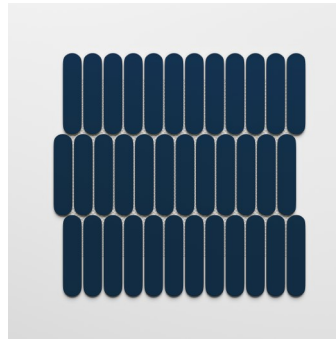

Ocean Blue

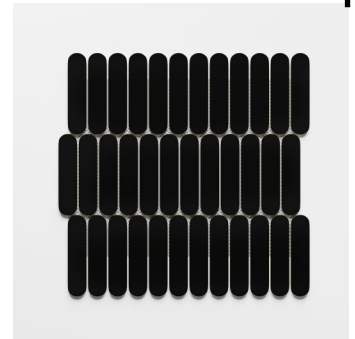

Black

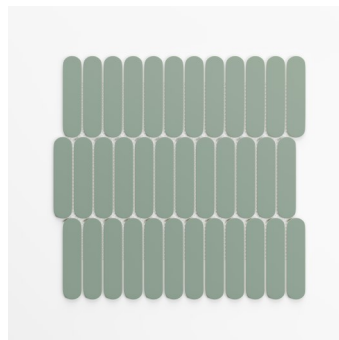

Sage

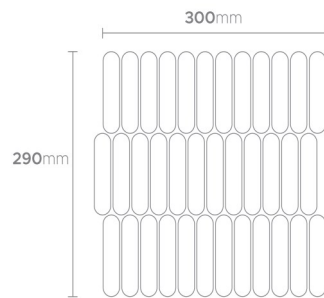

SIZE: 11.81" x 11.41"

MATERIAL TYPE: Porcelain

SURFACE FINISH: Glossy

Picket Collection

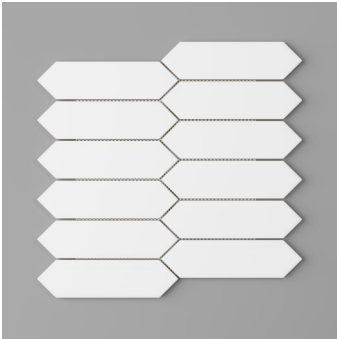

White

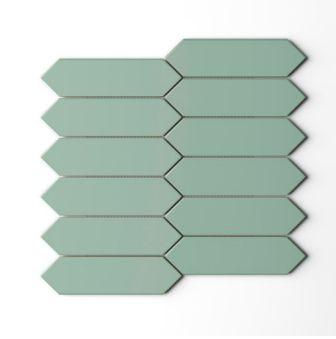

Sage

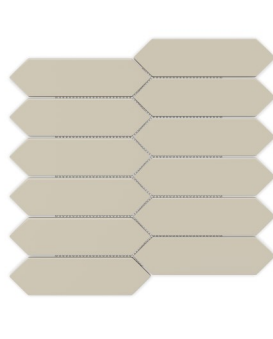

Taupe



Ocean Blue

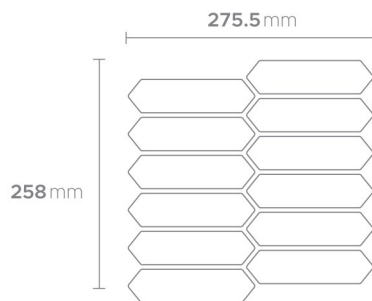

SIZE: 10.85" x 10.15"
MATERIAL TYPE: Porcelain
SURFACE FINISH: Glossy

Elongated Fan Collection



White

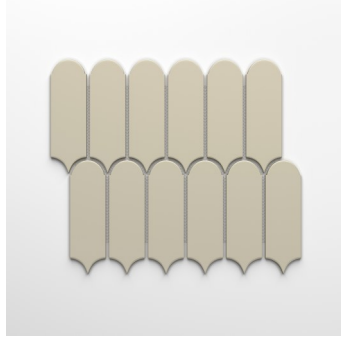

Taupe

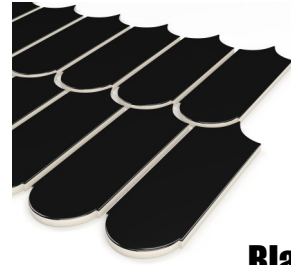

Black

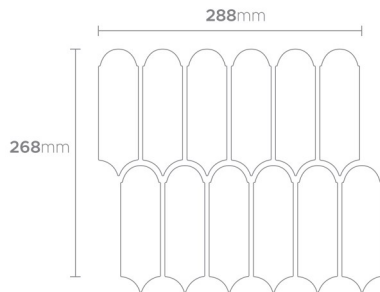

SIZE: 11.33" x 10.55" MATERIAL

TYPE: Porcelain

Surface FINISH: Glossy

3D Hexagon Collection

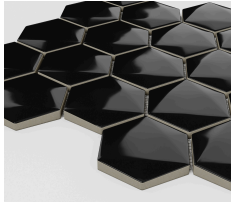

Black

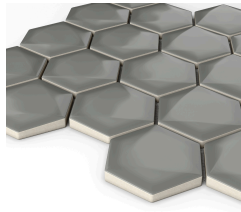

Dark Grey

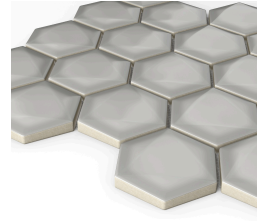

Light Grey

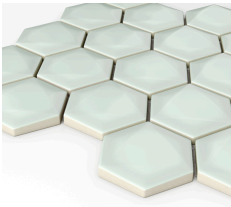

Mist

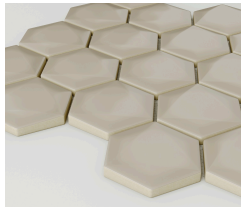

Taupe

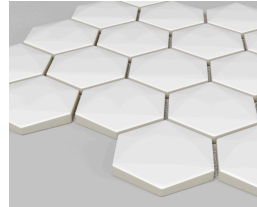

White

Size: 10.62" x 12.25"

Material Type: Ceramic

Finish: Gloss

Terms and Conditions

Buyer Understands that all tiles are subject to variations in technical specifications, including coefficient of friction due to the inherent variables in the raw materials and production process. Buyer must determine slip resistance suitability for any material use. There is no warranty as to the suitability for any material use. SpecCeramics does not warrant that the tiles will not scratch, chip or show signs of wear.

Claims concerning shade, appearance, caliber, finish or obvious defects in first choice production must be communicated before the tile is installed. No claims will be accepted for tile already installed for defects in other than first choice material. If there is a claim or a defect, SpecCeramics needs to be notified in writing within 60 days after the goods have been delivered.

Colors may differ due to printing and monitor settings.

Sizes are not to scale in the catalog.

To order samples—email samples@specceramics.com

Please contact us for current inventory levels. All tile is sold in full box qty only.

SpecCeramics accepts—visa, mc, & American express and charges a processing fee.

Corporate Office
Orange County Design Library

851 Enterprise Way
Fullerton, CA 92831
714.808.0134

San Diego Office
619.518.3011

Scottsdale / Las Vegas
480.798.6905

San Francisco Design Library
521 8th St

San Francisco, CA 94103
415.757.7733

Hawaii Office
415.987.7745

Central Coast CA
805.704.4138

West Hollywood Design Library
8687 Melrose Ave

Suite BM-11 (blue building)
West Hollywood, CA 90069
310.903.3392

Denver Area
480.798.6905