



 **ITALGRANITI**

I Travertini



INDEX

I Travertini ³

Bianco ¹²

Grigio ¹³

Beige ⁴⁴

Rosso ⁴⁵

Technical Information ⁷⁴



Design Andrea Parisio & Giuseppe Pezzano

Bellezza moderna e senza tempo

Italgraniti racconta la bellezza di un materiale nobile, di una pietra amata dagli architetti attraverso tutte le epoche, dall'antica Roma, al Rinascimento, fino all'era contemporanea. La modernità senza tempo del travertino e la sua armoniosa eleganza si esprimono in una collezione estremamente versatile anche per le cromie, che spaziano dai toni freddi alle nuance più calde e avvolgenti.

Timeless modern beauty

Italgraniti tells the story of the beauty of a noble material, of a stone beloved by architects throughout the ages, from ancient Rome, to the Renaissance and up to the contemporary era. The timeless modernity of travertine and its harmonious elegance are expressed in an extremely versatile collection also in terms of colours, which range from cold tones to warmer, enveloping nuances.

Modern und zeitlos schön

Italgraniti schildert die Entwicklung der Schönheit eines edlen Materials, eines seit je her von Architekten geliebten Stein, der vom alten Rom über die Renaissance bis in die heutige Zeit immer wieder gewählt wird. Die zeitlose Modernität des Travertins und seine harmonische Eleganz kommen in einer äußerst vielseitigen Kollektion zum Ausdruck, auch in Bezug auf die Farben, die von kalten Tönen bis zu wärmeren, umhüllenden Nuancen reichen.

Beauté moderne et intemporelle

Italgraniti raconte la beauté d'un matériau noble, une pierre aimée par les architectes à travers les âges, de la Rome antique à la Renaissance et jusqu'à l'époque contemporaine. La modernité intemporelle du travertin et son élégance harmonieuse s'expriment dans une collection extrêmement polyvalente, notamment en termes de couleurs, qui vont des tons froids aux nuances plus chaudes et enveloppantes.

Variazioni estetiche e di superficie

A seconda di come viene tagliato, il travertino svela texture differenti. La tecnologia Cross Cut riproduce l'estetica nuvolata ottenuta dal taglio perpendicolare al senso di stratificazione della pietra, con un effetto d'insieme omogeneo ed equilibrato. Vein Cut si ispira al taglio eseguito secondo il verso di stratificazione, evidenziando il disegno allungato e sinuoso delle venature.

Appearance and surface variation

Travertine reveals different textures depending on its cuts. The Cross Cut technology reproduces the cloudy aesthetics achieved by cutting perpendicular to the direction of layering of the stone, resulting in a homogeneous and balanced overall effect. Vein Cut is inspired by the cut made in the direction of layering, highlighting the elongated, sinuous design of the veins.

Optische Vielfältigkeit der Oberflächen

Je nachdem, wie er geschnitten wird, weist Travertin unterschiedliche Texturen auf. Die Cross Cut Technologie reproduziert die wolkige Optik, die durch das Schneiden senkrecht zur Schichtungsrichtung des Steins erreicht wird, mit einem homogenen und ausgewogenen Gesamteffekt. Vein Cut ist inspiriert sich am Schnitt in Richtung der Schichtung, die die längliche, gewundene Form der Adern hervorhebt.

Variations esthétiques et de surface

Selon sa coupe, le travertin révèle des textures différentes. La technologie Cross Cut reproduit l'esthétique nuageuse obtenue par une coupe perpendiculaire au sens de la stratification de la pierre, avec un effet global homogène et équilibré. Vein Cut s'inspire de la coupe effectuée dans le sens de la stratification, mettant en valeur le dessin allongé et sinueux des veines.



Vein Cut

Cross Cut

RealUp®

Con RealUp®, grafica e tridimensionalità raggiungono una sinergia inedita: il design complessivo della superficie ceramica ottiene una profondità e un livello di dettaglio unici. Dato cromatico e dato di struttura coincidono senza margine d'errore, conferendo alla superficie una ricchezza materica senza precedenti.

With RealUp®, graphics and three-dimensionality achieve an unprecedented synergy: the overall design of the ceramic surface achieves a unique depth and level of detail. Chromatic data and structural data coincide without any margin of error, giving the surface an unprecedented material richness.

Mit RealUp® gehen Grafik und Dreidimensionalität eine noch nie dagewesene Synergie ein: Das Gesamtdesign der keramischen Oberfläche erreicht eine einzigartige Tiefe und Detailgenauigkeit. Farb- und Texturdaten ohne jeglichen Spielraum für Fehler zusammen, was der Oberfläche einen noch nie dagewesenen Materialreichtum verleiht.

Avec RealUp®, art graphique et tridimensionnalité atteignent une synergie inédite : le design global de la surface céramique acquiert une profondeur et un niveau de détail uniques. Les données chromatiques et structurales coïncident sans marge d'erreur, conférant à la surface une richesse matérielle inégalée.

StrideUp®

StrideUp® è la tecnologia che espande la versatilità e le funzionalità del gres porcellanato per dare vita a una nuova tipologia di superfici che hanno un'elevata resistenza allo scivolamento e che, al tempo stesso, risultano morbide al tatto e facili da pulire. Una combinazione possibile grazie alla nanotecnologia di materie prime infinitesimali che compongono la superficie.

StrideUp®, is the technology that expands the versatility and functionality of porcelain stoneware to give life to a new type of surfaces that have a high slip resistance and, at the same time, are soft to the touch and easy to clean. A combination possible thanks to nanotechnology of raw materials infinitesimal that make up the surface.

Mit der Technologie StrideUp® wird die Vielseitigkeit und Funktionalität von Feinsteinzeug erweitert. Die neue Art von Oberfläche weist eine hohe Rutschfestigkeit und weiche Haptik auf, ist aber trotzdem leicht zu reinigen. Eine Kombination, die durch die Nanotechnologie der extrem feinen Rohstoffe, aus denen die Oberfläche besteht, ermöglicht wird.

StrideUp® est la technologie qui augmente la polyvalence et les fonctionnalités du grès cérame pour créer un nouveau type de surfaces offrant une résistance élevée au glissement tout en étant douces au toucher et faciles à nettoyer. Une combinaison possible grâce à la nanotechnologie de matières premières infinitésimales qui composent la surface.

Decori geometrici e fascino essenziale

Geometrie rigorose e al tempo stesso aperte a molteplici composizioni per i decori, che valorizzano la sofisticata essenzialità del travertino. Delicate micro rigature e semplici semicerchi, sono liberamente combinabili fra loro nel fondo e in primo piano, impreziosendo le texture con effetti estetici sempre diversi. E per ottenere un suggestivo dinamismo tridimensionale, si possono accostare le lastre verticali 60x120 nei diversi spessori disponibili.

Geometric decorations and essential charm

Rigorous geometries, yet open to multiple compositions for the decorations, which enhance the sophisticated essentiality of travertine. Delicate micro stripes and simple semi-circles can be freely combined in the background and foreground, enhancing the textures with ever-changing aesthetic effects. And to achieve a striking three-dimensional dynamism, the 60x120 vertical slabs can be combined in the different thicknesses available.

Geometrische Dekors und essentieller Charme

Strenge aber gleichzeitig offenen vielfältige Kompositionen offene Geometrien, die die raffinierte Wesentlichkeit des Travertins hervorheben. Zarte Mikrostreifen und einfache Halbkreise können im Vorder- und Hintergrund frei kombiniert werden, wodurch die Texturen mit ständig wechselnden ästhetischen Effekten aufgewertet werden. Und um eine beeindruckende dreidimensionale Dynamik zu erzielen, können die 60x120 vertikalen Platten in den verschiedenen verfügbaren Stärken kombiniert werden.

Décors géométriques et charme essentiel

Des géométries rigoureuses tout en étant ouvertes à de multiples compositions pour les décors, qui mettent en valeur l'essentialité sophistiquée du travertin. De délicates micro-rayures et de simples demi-cercles peuvent être combinés entre eux sur le fond et en premier plan, mettant en valeur les textures avec des effets esthétiques toujours différents. Et pour obtenir un dynamisme tridimensionnel suggestif, les dalles verticales 60x120 peuvent être combinées dans les différentes épaisseurs disponibles.



**LIGHT
COLORS**

I Travertini Bianco

**FOR A
SOPHISTICATED
HOME**

CONTEMPORARY

I Travertini Grigio

TIMELESS

I Travertini Bianco. Una tonalità piena di luce che richiama le varietà più pregiate del travertino ed emana una sensazione di equilibrio e leggerezza. Perfetta per amplificare gli spazi, è ideale sia per uno stile minimale che classico. Nelle finiture Cross Cut e Vein Cut che ne valorizzano la raffinatezza.

I Travertini Bianco. A light-filled shade that recalls the finest variations of travertine and provides a feeling of balance and lightness. Perfect for widening spaces, it is ideal for both minimalist and classic styles. Cross Cut and Vein Cut finishes enhance its refinement.

I Travertini Bianco. Ein lichtdurchfluteter Farbton, der an die feinsten Travertinarten erinnert und ein Gefühl von Gleichgewicht und Leichtigkeit vermittelt. Dieses Produkt eignet sich perfekt zur Erweiterung des Raumgefühls und passt sowohl zum minimalistischen als auch zum klassischen Stil. Die Ausführungen Cross Cut und Vein Cut verstärken zudem die Raffinesse.

I Travertini Bianco. Une teinte chargée de lumière qui rappelle les variétés de travertin les plus prisées et diffuse une sensation d'équilibre et de légèreté. Parfaite pour accroître la perception d'espace, elle est idéale pour un style minimaliste ou classique, aussi bien dans les finitions Cross Cut que Vein Cut qui en accentuent le raffinement.

I Travertini Grigio. Una nuance decisamente contemporanea, molto amata e utilizzata nelle architetture moderne. Geometrie, linee e volumi vengono esaltati nella loro essenzialità elegante da questa tonalità, che nelle finiture Cross Cut e Vein Cut esprime effetti materici sempre diversi e interessanti.

I Travertini Grigio. A decidedly contemporary shade, much loved and used in modern architecture. Geometries, lines and volumes are emphasised in their elegant essentiality by this shade, which expresses ever-changing and interesting textural effects in the Cross Cut and Vein Cut finishes.

I Travertini Grigio. Ein ausgesprochen zeitgenössischer Farbton, der in der modernen Architektur verwendet wird und auf großen Anklang stößt. Geometrien, Linien und Volumen werden durch diesen Farbton in ihrer eleganten Wesentlichkeit hervorgehoben, der in den Ausführungen Cross Cut und Vein Cut immer wieder neue und interessante Materialeffekte zum Ausdruck bringt.

I Travertini Grigio. Une nuance franchement contemporaine, très appréciée et utilisée dans les architectures modernes. Les formes, les lignes et les volumes sont mis en valeur dans leur aspect essentiel élégant par cette teinte qui, dans les finitions Cross Cut et Vein Cut, exprime des effets matériels toujours différents et intéressants.



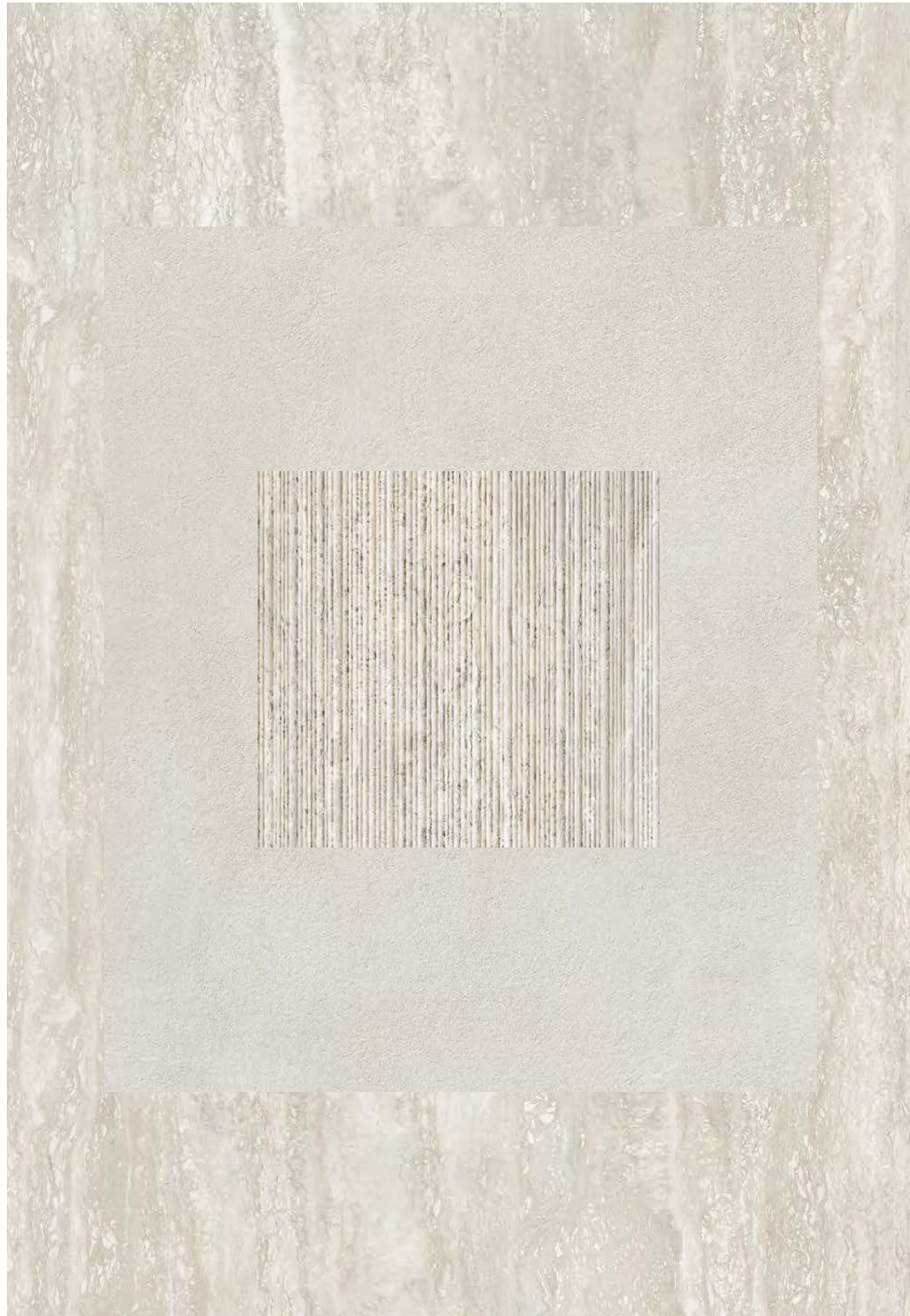

I Travertini Grigio Cross Cut, I Travertini Grigio Decoro Radio 3D, I Cementi White



I Travertini Grigio Cross Cut, I Travertini Grigio Decoro Radio 3D, I Cementi White





I Travertini Grigio Vein Cut, I Cementi White, Nuances Luce





I Travertini Bianco Vein Cut, I Travertini Bianco Muretto, I Cementi Dark

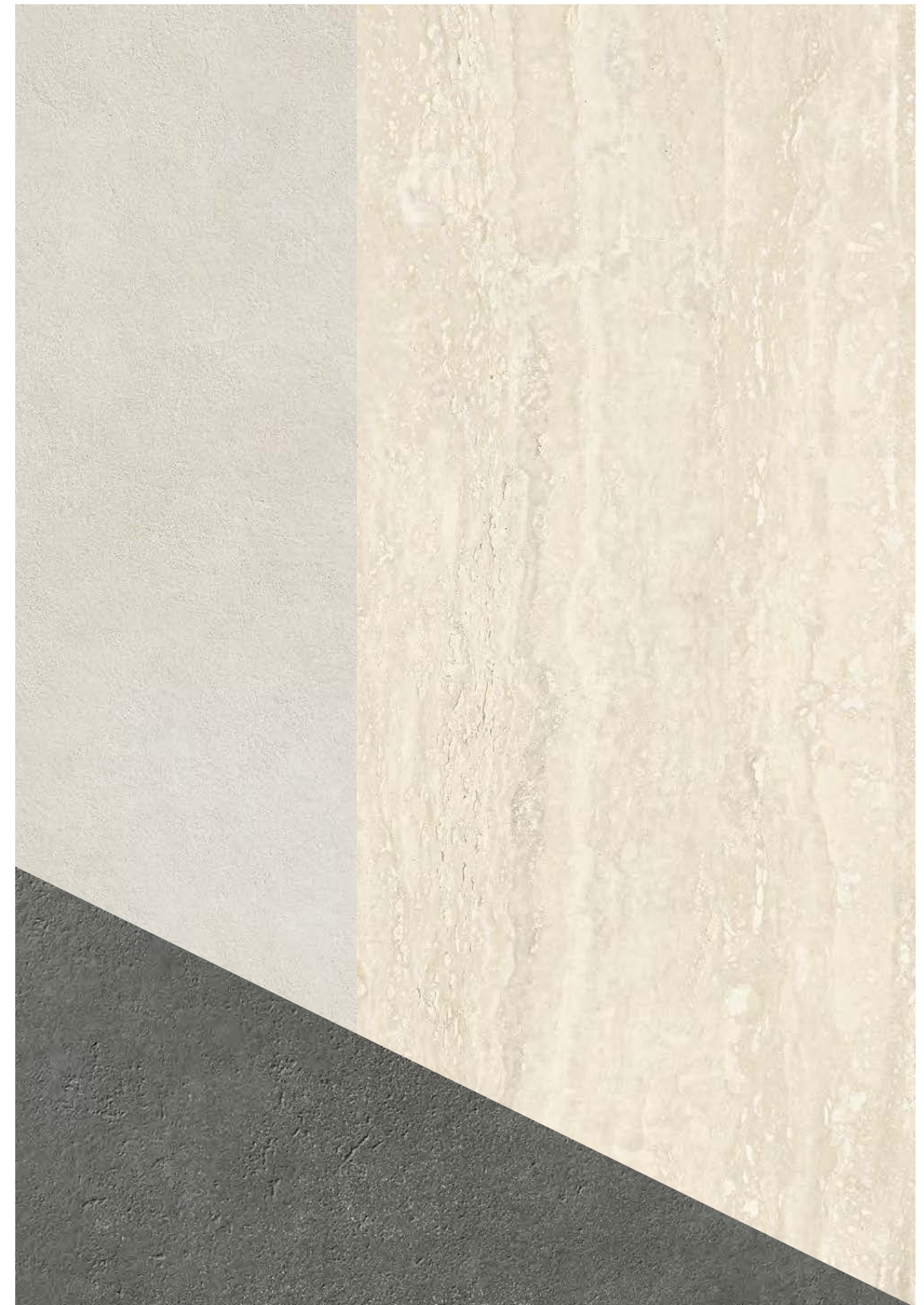

I Travertini

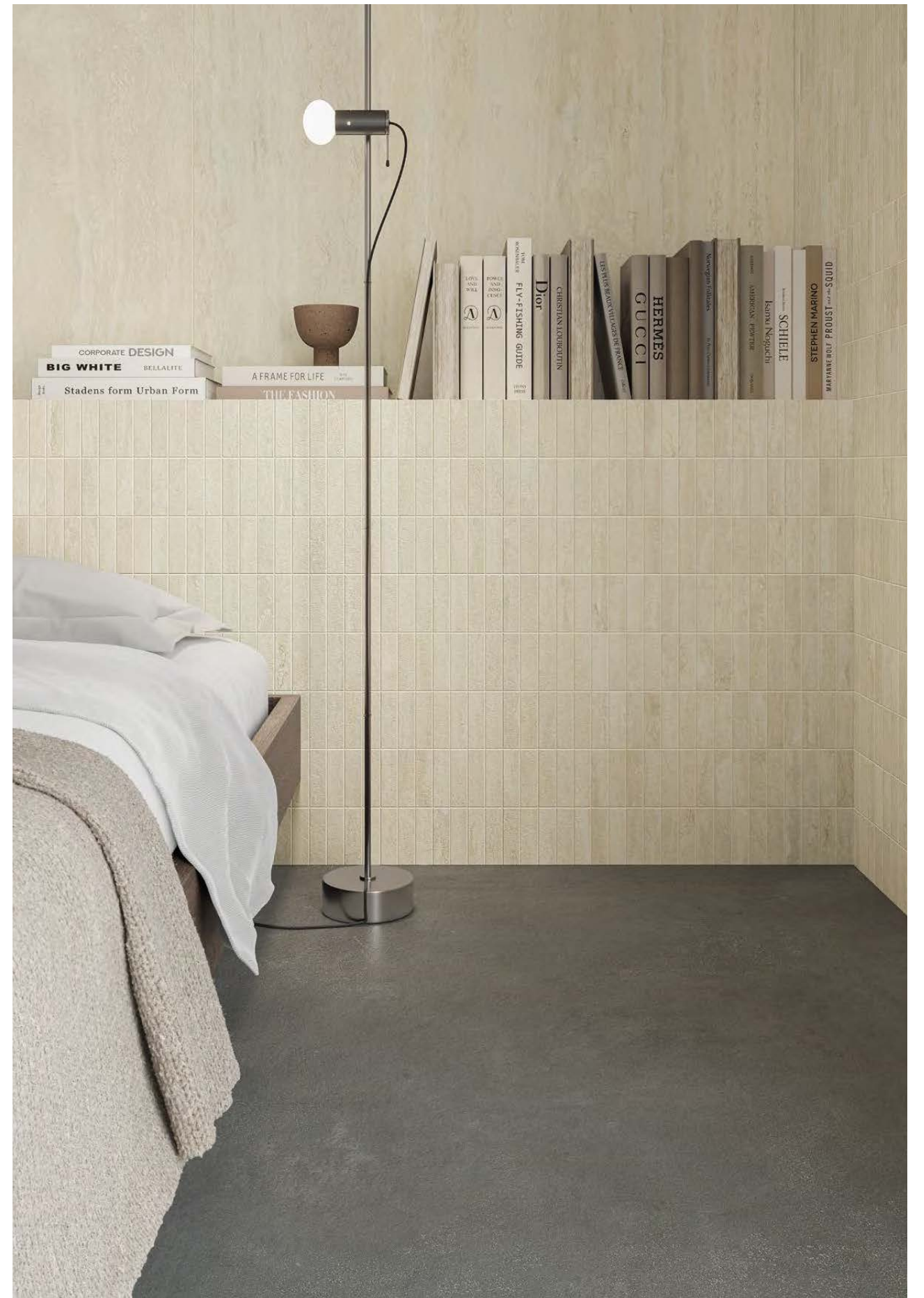
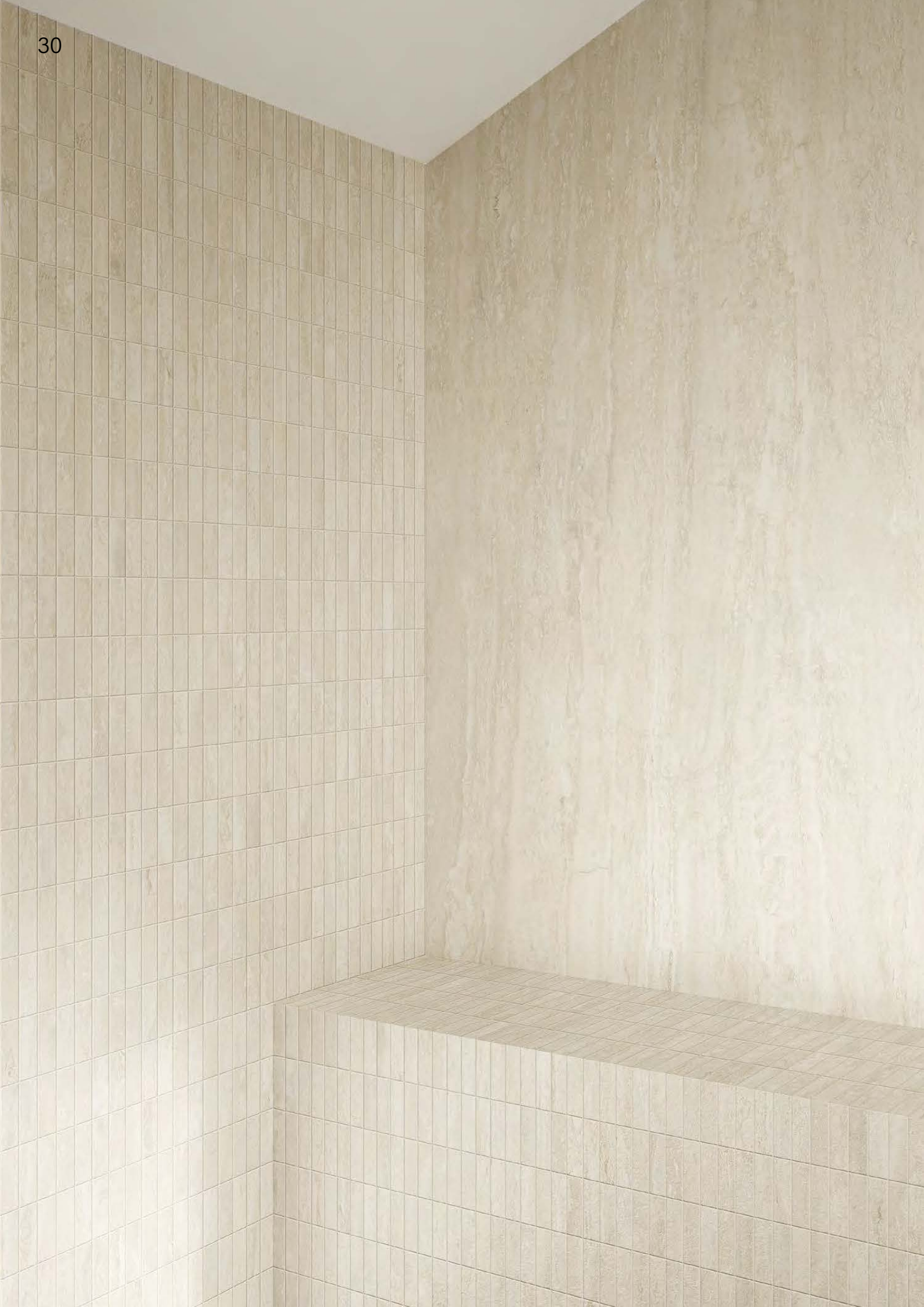

I Travertini Bianco Vein Cut, I Travertini Bianco Muretto, I Cementi Dark







I Travertini Grigio Vein Cut, I Cementi Dark



I Travertini





I Travertini Bianco Vein Cut, I Tavertini Bianco Cross Cut, I Travertini Grigio Decoro Radio 3D, I Cementl White, Nuances Luce



I Travertini

**WARM
COLORS**

I Travertini Beige

**FOR A
WELCOMING
HOME**

**MODERN
AND ORIGINAL**

I Travertini Rosso

LUXURY

I Travertini Beige. Atmosfere calde e confortevoli con il tocco delicato di questa tonalità che rende ogni spazio più accogliente. Un colore naturale, ispirato al travertino classico ma che si presta anche alle architetture più moderne e che nelle finiture Cross Cut e Vein Cut svela tutto il suo fascino.

I Travertini Beige. Warm and comfortable atmospheres with the delicate touch of this shade make any space cosy. A natural colour, inspired by classic travertine, but which also lends itself to more modern architecture and which reveals all its charm in the Cross Cut and Vein Cut finishes.

I Travertini Beige. Die warmen und behaglichen Atmosphären mit dem zarten Hauch dieses Farbtons gestalten jeden Raum gemütlich. Eine natürliche Farbe, die vom klassischen Travertin inspiriert ist, sich aber auch für eine modernere Architektur eignet und in den Ausführungen Cross Cut und Vein Cut ihren ganzen Charme entfaltet.

I Travertini Beige. Des atmosphères chaleureuses et confortables grâce à la touche délicate de cette teinte qui rend chaque pièce encore plus accueillante. Une couleur naturelle, inspirée du travertin classique, mais qui convient également aux architectures les plus modernes et dévoile tout son charme dans les finitions Cross Cut et Vein Cut.

I Travertini Rosso. Un colore prezioso che richiama il travertino originario dell'antica Persia. Una tonalità avvolgente che trova diverse intensità nelle finiture Cross Cut e Vein Cut, con effetti decorativi di grande eleganza. La nuance perfetta per donare a interni ed esterni un lusso inconfondibile.

I Travertini Rosso. A precious colour reminiscent of travertine from ancient Persia. An enveloping shade that finds different intensities in the Cross Cut and Vein Cut finishes, with very elegant decorative effects. The perfect shade to provide interiors and exteriors with unmistakable luxury.

I Travertini Rosso. Eine kostbare Farbe, die an Travertin aus dem alten Persien erinnert. Ein umhüllender Farbton, der in den Ausführungen Cross Cut und Vein Cut unterschiedliche Intensitäten mit sehr eleganten dekorativen Effekten aufweist. Der perfekte Farbton für Innen- und Außenbereiche mit einem unverwechselbar luxuriösen Touch.

I Travertini Rosso. Une couleur précieuse qui rappelle le travertin originaire de l'ancienne Perse. Une teinte enveloppante qui offre diverses intensités dans les finitions Cross Cut et Vein Cut, avec des effets décoratifs extrêmement élégants. La nuance parfaite pour apporter un luxe incomparable aux espaces intérieurs et extérieurs.







I Travertini Rosso Vein Cut, I Cementi Flax



I Travertini









I Travertini Beige Vein Cut, I Travertini Beige Listello Tratto, I Travertini Beige Decoro Rilievo 3D, I Cementi Beige



I Travertini



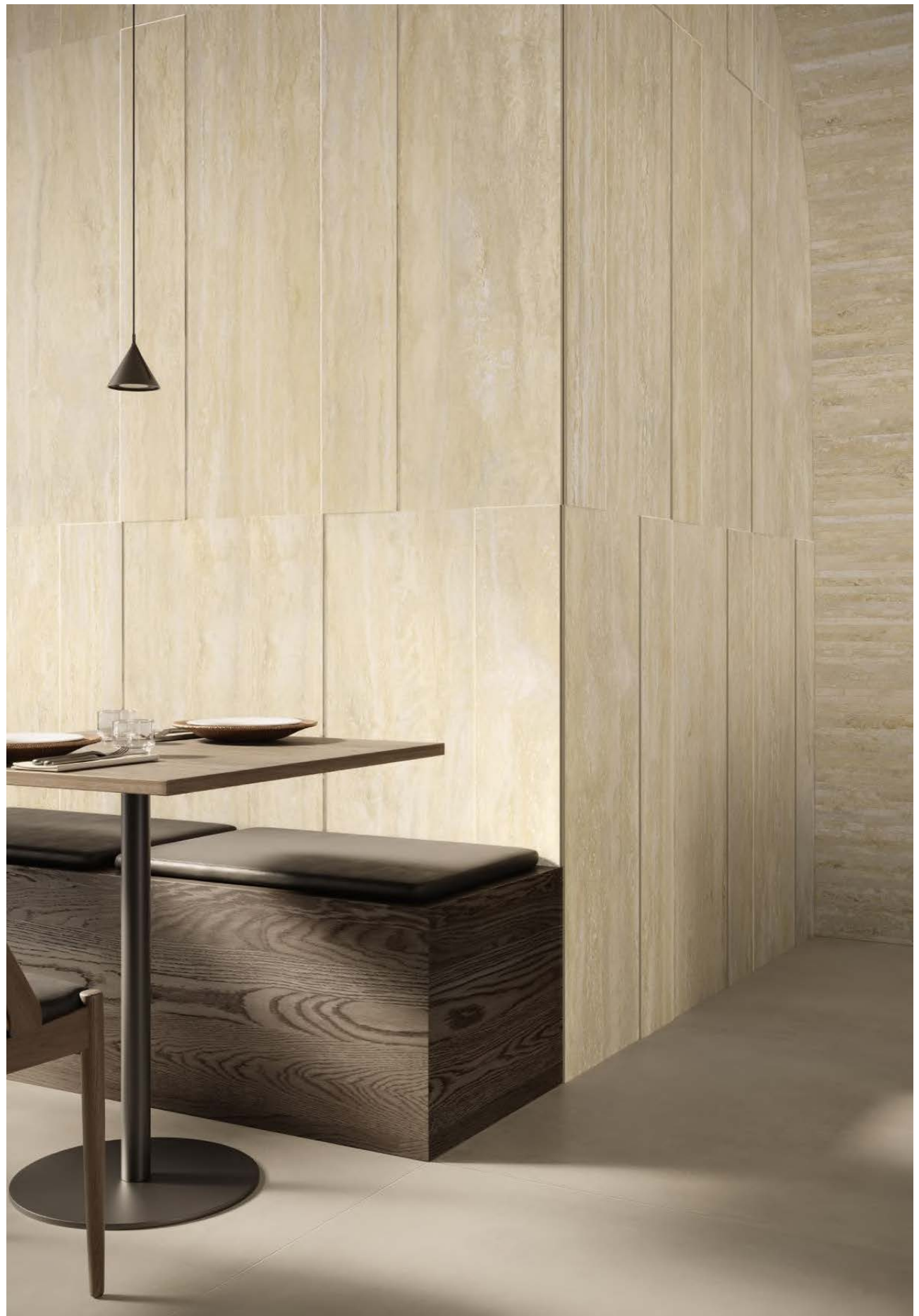

I Travertini Beige Decoro Rilievo 3D, I Travertini Rosso Vein Cut Ribbed, I Travertini Beige Listello Tratto, I Cementi Taupe

Technical Information

I Travertini

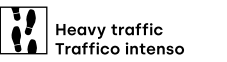

Colori disponibili / Available colours



Bianco Vein Cut

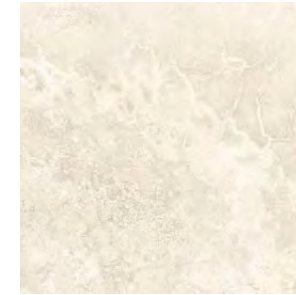

Bianco Cross Cut



Bianco Vein Cut Ribbed



Beige Vein Cut

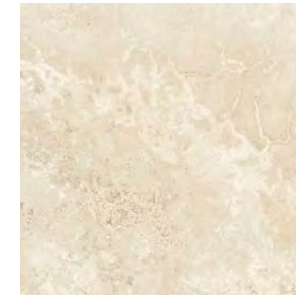

Beige Cross Cut

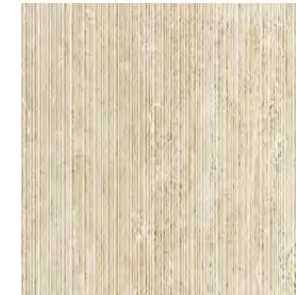

Beige Vein Cut Ribbed

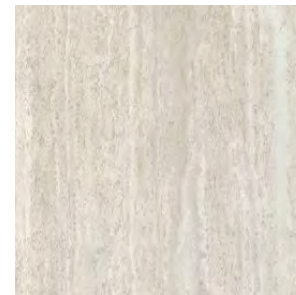

Grigio Vein Cut

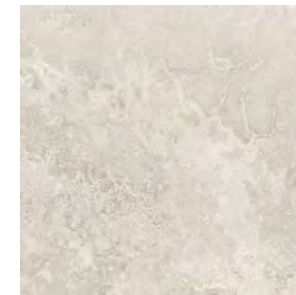

Grigio Cross Cut

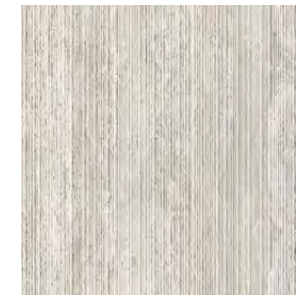

Grigio Vein Cut Ribbed



Rosso Vein Cut

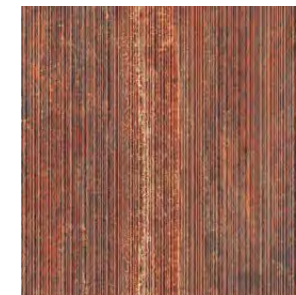

Rosso Vein Cut Ribbed



Bianco Vein Cut



Bianco Cross Cut



Bianco Vein Cut Ribbed



Il Decoro Ribbed non ha continuità di struttura tra un pezzo e l'altro. / Le décor Ribbed n'a pas de continuité entre une pièce et l'autre. / Ribbed decor has no continuity of texture between the pieces. / Bei dem Dekor Ribbed gibt es keine Kontinuität der Linienstruktur zwischen einem Stück und dem nächsten.

	6 mm MEGA	9 mm Real Up + StrideUp			20 mm OPEN	
	120 x 280 cm 47 ¹ / ₄ " x 110 ¹ / ₄ "	30 x 60 cm 11 ⁷ / ₈ " x 23 ¹ / ₂ "	60 x 60 cm 23 ¹ / ₂ " x 23 ¹ / ₂ "	60 x 120 cm 23 ¹ / ₂ " x 47 ¹ / ₄ "	120 x 120 cm 47 ¹ / ₄ " x 47 ¹ / ₄ "	80 x 160 cm 31 ¹ / ₂ " x 62 ⁷ / ₈ "
Bianco Vein Cut	TR01XPA	TR0163		TR01BA	TR01GA	TR01BA2
Bianco Cross Cut		TR0263	TR0268	TR02BA	TR0212	TR02BA2
Bianco Vein Cut Ribbed				TR01BAR		
Bianco Vein Cut Antislip				TR01BAA		
Bianco Cross Cut Antislip				TR02BAA		

Beige Vein Cut



Beige Cross Cut



Beige Vein Cut Ribbed



Il Decoro Ribbed non ha continuità di struttura tra un pezzo e l'altro. / Le décor Ribbed n'a pas de continuité entre une pièce et l'autre. / Ribbed decor has no continuity of texture between the pieces. / Bei dem Dekor Ribbed gibt es keine Kontinuität der Linienstruktur zwischen einem Stück und dem nächsten.

	6 mm MEGA	9 mm Real Up + StrideUp			20 mm OPEN	12 mm Italstone
	120 x 280 cm 47 ¹ / ₄ " x 110 ¹ / ₄ "	30 x 60 cm 11 ⁷ / ₈ " x 23 ¹ / ₂ "	60 x 60 cm 23 ¹ / ₂ " x 23 ¹ / ₂ "	60 x 120 cm 23 ¹ / ₂ " x 47 ¹ / ₄ "	120 x 120 cm 47 ¹ / ₄ " x 47 ¹ / ₄ "	80 x 160 cm 31 ¹ / ₂ " x 62 ⁷ / ₈ "
Beige Vein Cut	TR03XPA	TR0363		TR03BA	TR03GA	TR03BA2
Beige Cross Cut		TR0463	TR0468	TR04BA	TR0412	TR04BA2
Beige Vein Cut Ribbed				TR03BAR		
Beige Vein Cut Antislip				TR03BAA		
Beige Cross Cut Antislip				TR04BAA		

Grigio Vein Cut



Grigio Cross Cut



Grigio Vein Cut Ribbed



Il Decoro Ribbed non ha continuità di struttura tra un pezzo e l'altro. / Le décor Ribbed n'a pas de continuité entre une pièce et l'autre. / Ribbed decor has no continuity of texture between the pieces. / Bei dem Dekor Ribbed gibt es keine Kontinuität der Linienstruktur zwischen einem Stück und dem nächsten.

Rosso Vein Cut



Rosso Vein Cut Ribbed



Il Decoro Ribbed non ha continuità di struttura tra un pezzo e l'altro. / Le décor Ribbed n'a pas de continuité entre une pièce et l'autre. / Ribbed decor has no continuity of texture between the pieces. / Bei dem Dekor Ribbed gibt es keine Kontinuität der Linienstruktur zwischen einem Stück und dem nächsten.

■ 6 mm
MEGA



120 x 280 cm
47^{1/4}" x 110^{1/4}"

■ 9 mm
Real Up + StrideUp



30 x 60 cm
11^{7/8}" x 23^{1/2}"



60 x 60 cm
23^{1/2}" x 23^{1/2}"



60 x 120 cm
23^{1/2}" x 47^{1/4}"



120 x 120 cm
47^{1/4}" x 47^{1/4}"



80 x 160 cm
31^{1/2}" x 62^{7/8}"

Grigio Vein Cut	■ TR05XPA	■ TR0563	■ TR05BA	■ TR05GA
Grigio Cross Cut		■ TR0663	■ TR0668	■ TR06BA
			■ TR0612	
Grigio Vein Cut Ribbed			■ TR05BAR	
Grigio Vein Cut Antislip			■ TR05BAA	
Grigio Cross Cut Antislip			■ TR06BAA	

■ 9 mm
Real Up + StrideUp



60 x 120 cm
23^{1/2}" x 47^{1/4}"



80 x 160 cm
31^{1/2}" x 62^{7/8}"

Rosso Vein Cut	■ TR07BA	■ TR07GA
Rosso Vein Cut Ribbed	■ TR07BAR	

Mosaico (9 mm)



Muretto (9 mm)



Muretto (6 mm)

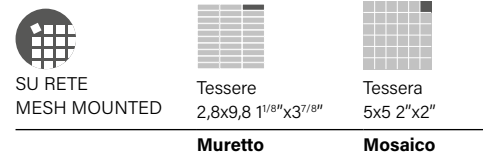
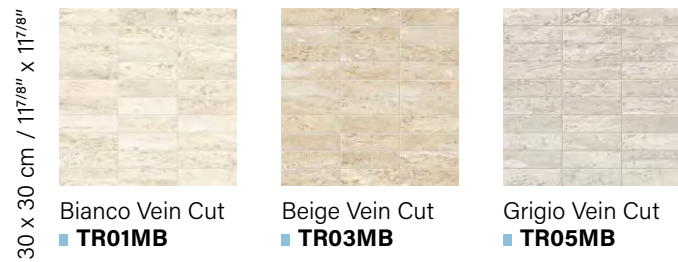

Listello Tratto (6 mm / 9 mm)

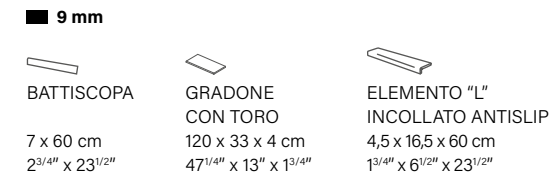
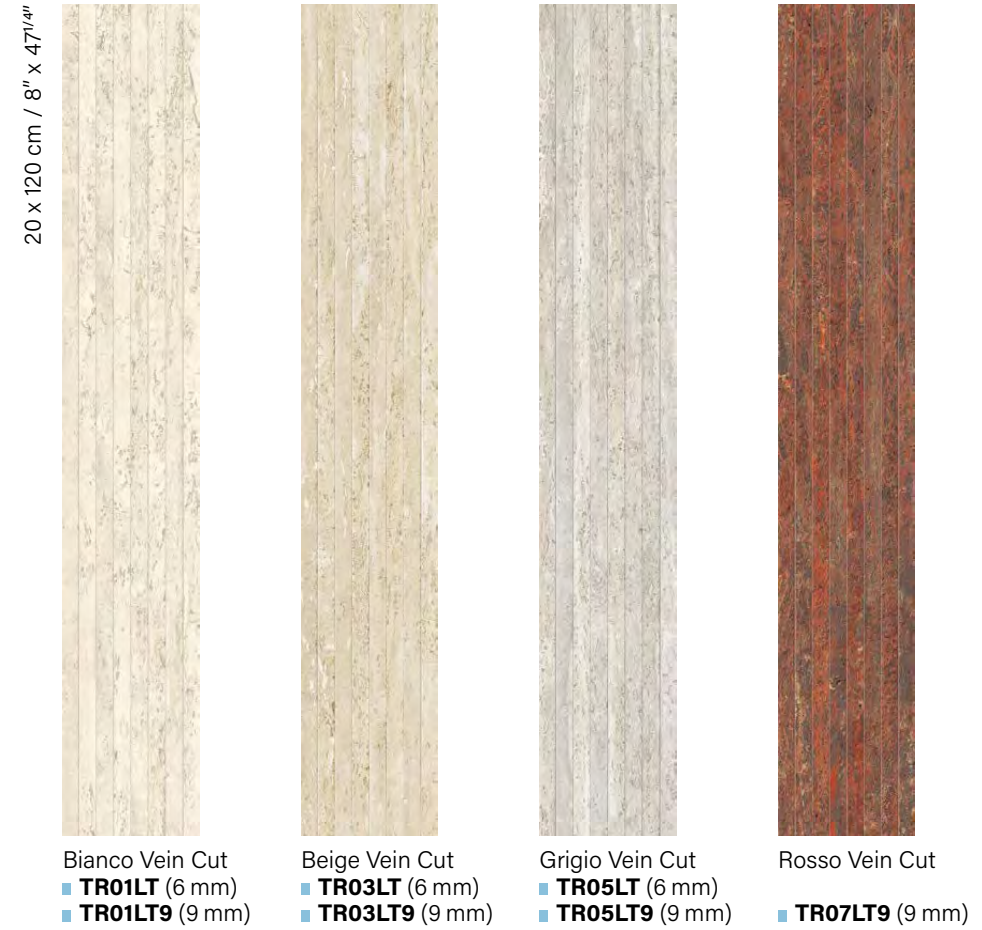

Bianco Vein Cut	TR0176	TR01GT2	TR0195I
Bianco Cross Cut	TR0276	TR02GT2	TR0295I
Beige Vein cut	TR0376	TR03GT2	TR0395I
Beige Cross Cut	TR0476	TR04GT2	TR0495I
Grigio Vein Cut	TR0576	TR05GT2	TR0595I
Grigio Cross Cut	TR0676	TR06GT2	TR0695I
Rosso Vein Cut	TR0776	TR07GT2	

Decoro Rilievo 3D (9 mm)

20 x 120 cm / 8" x 47 1/4" - 40 x 120 cm / 15 3/4" x 47 1/4" - 60 x 120 cm / 23 3/4" x 47 1/4"



Bianco Vein Cut
■ TR01DRL



Beige Vein Cut
■ TR03DRL



Grigio Vein Cut
■ TR05DRL

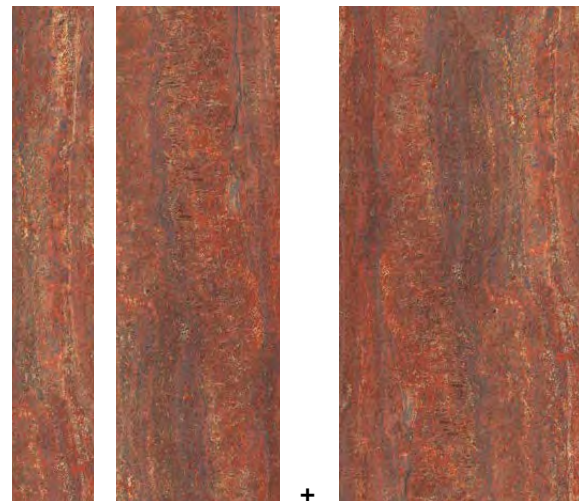

Rosso Vein Cut
■ TR07DRL

■ 9 mm
Real Up + StrideUp



120 x 120 cm (20 x 120 2pz - 40 x 120 2pz)
47 1/4" x 47 1/4" (8" x 47 1/4" 2pcs - 15 3/4" x 47 1/4" 2pcs)

Bianco Vein Cut ■ TR01DRL

Beige Vein Cut ■ TR03DRL

Grigio Vein Cut ■ TR05DRL

Rosso Vein Cut ■ TR07DRL

Le scatole dei listelli sono così composte / The listels boxes are composed as follows
/ Jeder Karton besteht aus den folgenden Produkten / Les boites des listels sont composées par :

- 1 pezzo 20x120
- 1 pezzo 20x120 inciso sul retro / engraved on the back / auf der Rückseite eingepägt / gravé au dos
- 1 pezzo 40x120
- 1 pezzo 40x120 inciso sul retro / engraved on the back / auf der Rückseite eingepägt / gravé au dos

20 x 120 - 40 x 120 inciso sul retro / 8" x 47 1/4" - 15 3/4" x 47 1/4" engraved on the back

Schemi di posa a 3 formati / Installation systems with 3 sizes

Per garantire un progetto di posa a regola d'arte, consigliamo uno schema random alternando - ai formati 20x120 e 40x120 - il fondo 60x120 cm.

To ensure a proper installation, we recommend a random pattern by alternating the 20x120cm (8"x48") and 40x120cm (32"x48") sizes with the 60x120cm (24"x48") field tile.

Um ein fachgerechtes Verlegebild zu gewährleisten, empfehlen wir ein zufälliges Schema, bei dem sich die Formate 20x120 und 40x120 mit den 60x120 Grundfliesen abwechseln.

Pour assurer u projet réalisé dans la règle de l'art, nous préconisons un schéma aléatoire en alternant aux formats 20x120 et 40x120 l'uni en 60x120.

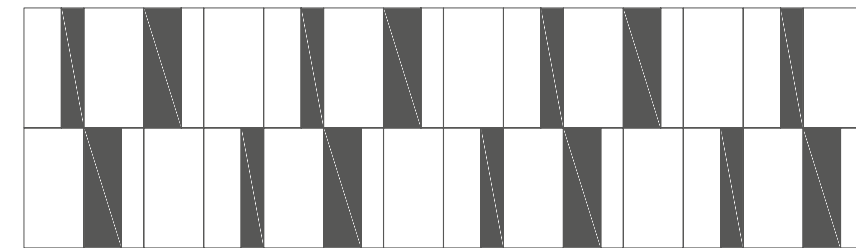
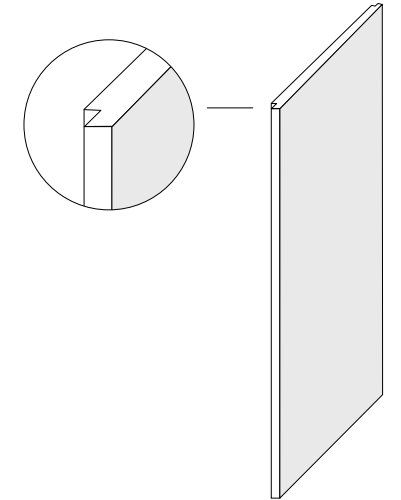

Nello schema accanto i formati incisi sul retro sono indicati dal colore grigio. / In the pattern beside, the sizes engraved on the back are indicated by the color grey. / In der nebenstehenden Abbildung sind die auf der Rückseite eingepägten Formate durch die Farbe Grau gekennzeichnet. / Dans le tableau ici à coté, les formats gravés sur le dos sont indiqués en gris.

SIZES	20x120 20x120 inciso sul retro / engraved on the back 40x120 40x120 inciso sul retro / engraved on the back	60x120
% MQ	50%	50%

Nell'immaginare questo decoro gli architetti Andrea Parisio e Giuseppe Pezzano si sono ispirati alla plasticità dei rivestimenti lapidei che caratterizzano l'architettura dei palazzi italiani.

Il decoro abbina un listello posato in modo planare ad un listello il cui lato maggiore viene posato in sovrapposizione. Si crea così un modulo dall'originale effetto di tridimensionalità. La sovrapposizione è possibile grazie all'incisione effettuata sul retro del listello, che in fase di installazione genera l'effetto 3D.

Die Architekten Andrea Parisio und Giuseppe Pezzano haben sich bei der Entwicklung dieses Dekors von der Plastizität der Steinverkleidungen inspirieren lassen, die für die Architektur italienischer Paläste charakteristisch sind. Das Dekor kombiniert einen flach verlegten Riemen mit einem Riemen, dessen längere Seite überlappend verlegt ist. So entsteht ein Modul mit einer originellen dreidimensionalen Optik. Die Überlappung ist dank der Gravur auf der Rückseite des Riemens möglich, die bei der Verlegung die 3D-Optik erzeugt.

In imagining this decoration, the architects Andrea Parisio and Giuseppe Pezzano were inspired by the plasticity of the wall stone that characterize the architecture of Italian buildings.

The decoration combines a listel laid flatly with a listel which longer side is installed overlapping. This creates a module with an original three-dimensional effect. The overlapping is possible thanks to the engraving made on the back of the strip, which generates the 3D effect.

Pour concevoir cette décoration, les architectes Andrea Parisio et Giuseppe Pezzano se sont inspirés de la plasticité des revêtements en pierre qui caractérisent l'architecture des palais italiens. La décoration combine un listel posé à plat et un listel dont le côté le plus long est posé en superposition. Ceci permet de créer un module offrant un effet tridimensionnel original. La superposition est possible grâce à l'incision effectuée à l'arrière du listel qui, lors de l'installation, génère l'effet 3D.

Decoro Radio 3D (9 mm)

120 x 120 cm / 47^{1/4}" x 47^{1/4}"Bianco Vein Cut
■ TR01DRDBeige Vein Cut
■ TR03DRDGrigio Vein Cut
■ TR05DRDRosso Vein Cut
■ TR07DRD■ 9 mm
Real Up + StrideUp120 x 120 cm
47^{1/4}" x 47^{1/4}"

Bianco Vein Cut ■ TR01DRD

Beige Vein Cut ■ TR03DRD

Grigio Vein Cut ■ TR05DRD

Rosso Vein Cut ■ TR07DRD

Schemi di posa / Installation systems



Posa A



Posa B



Posa C

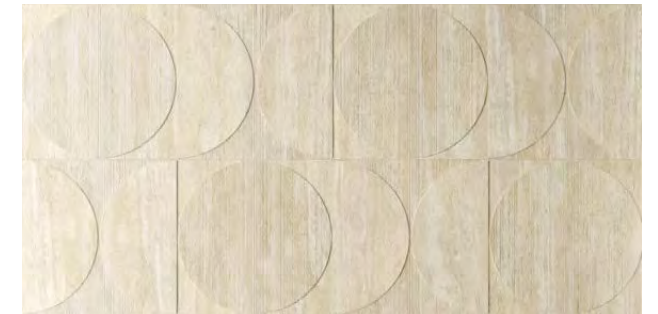

Posa D

Ideato dagli architetti Andrea Parisio e Giuseppe Pezzano il decoro gioca con le geometrie circolari e verticali, generando combinazioni sempre diverse dalla forte connotazione grafica. Radio 3D abbina fondo vein cut e ribbed in due moduli complementari: la mezza luna interna è in rilievo rispetto al bordo, creando un modulo dall'effetto tridimensionale che valorizza ulteriormente i motivi geometrici.

Ogni scatola viene venduta contenente 2 pezzi che formano una composizione 120 x 120 cm.

Designed by architects Andrea Parisio and Giuseppe Pezzano, the decoration plays with circular and vertical geometries, generating ever-changing combinations with a strong graphic feature. Radio 3D combines the vein cut tile and the ribbed deco in two complementary modules: the internal half moon is in relief compared to the external portion of the piece, creating a module with a three-dimensional effect that further enhances the geometric motifs.

Each box is sold containing 2 pieces that form a composition 120 x 120 cm.

Die von den Architekten Andrea Parisio und Giuseppe Pezzano entworfene Dekoration spielt mit kreisförmigen und vertikalen Geometrien und erzeugt so immer wieder neue grafische Kombinationen. Radio 3D kombiniert die Untergründe Vein Cut und Ribbed in zwei komplementären Modulen: Der innere Halbmond hebt sich von der Kante ab, wodurch ein Modul mit dreidimensionaler Optik entsteht, die die geometrischen Muster noch verstärkt.

Jeder Verkaufskarton enthält 2 Platten, die eine 120 x 120 cm große Komposition bilden.

Conçue par les architectes Andrea Parisio et Giuseppe Pezzano, la décoration joue avec les formes circulaires et verticales pour générer des combinaisons toujours différentes offrant une forte connotation graphique. Radio 3D associe un fond Vein Cut et Ribbed en deux modules complémentaires : la demi-lune interne est en relief par rapport au bord et crée un effet tridimensionnel qui met encore plus en valeur les motifs géométriques.

Chaque boîte contient 2 pièces qui forment une composition de 120x120 cm.

— 6 mm + — 9 mm + ■ 20 mm OPEN

SIZE CHART AND PACKING

LE DIMENSIONI OPERATIVE DEI SINGOLI FORMATI SONO: / THE WORKING SIZES OF THE INDIVIDUAL COMMERCIAL SIZES ARE: / DIE OPERATIVEN ABMESSUNGEN DER EINZELNEN FORMATE SIND: / LES DIMENSIONS UTILES DES FORMATS SONT LES SUIVANTES :

				PCS / BOX	M ² / BOX	KG / BOX	BOX / PALLET	M ² / PALLET	KG / PALLET
800x1600 mm = 797x1596 mm 1200x1200 mm = 1195x1195 mm 600x1200 mm = 596,5x1195 mm	800x800 mm = 797x797 mm 400x800 mm = 397,2x797 mm	600x600 mm = 596,5x596,5 mm 300x600 mm = 297,2x596,5 mm							
IMBALLI / PACKING / VERPACKUNGEN / EMBALLAGES									
80x160 cm - 31 ^{1/2} "x62 ^{7/8} "	Thick 9 mm	RealUp + StrideUp	PZ / PCS	2	M ² 2,56	KG 54,78	PZ / PCS 18	M ² 46,08	KG 1006,05
120x120 cm - 47 ^{1/4} "x47 ^{1/4} "	Thick 9 mm	RealUp + StrideUp	PZ / PCS	2	M ² 2,88	KG 59,67	PZ / PCS 18	M ² 51,84	KG 1094,16
60x120 cm - 23 ^{1/2} "x47 ^{1/4} "	Thick 9 mm	RealUp + StrideUp Ribbed	PZ / PCS	2	M ² 1,44	KG 29,24	PZ / PCS 36	M ² 51,84	KG 1072,67
60x120 cm - 23 ^{1/2} "x47 ^{1/4} "	Thick 9 mm	Antislip	PZ / PCS	2	M ² 1,44	KG 28,17	PZ / PCS 36	M ² 51,84	KG 1034,30
OPEN 60x120 cm - 23 ^{1/2} "x47 ^{1/4} "	Thick 20 mm	Antislip	PZ / PCS	1	M ² 0,72	KG 31,87	PZ / PCS 36	M ² 25,92	KG 1167,60
60x60 cm - 23 ^{1/2} "x23 ^{1/2} "	Thick 9 mm	RealUp + StrideUp	PZ / PCS	4	M ² 1,44	KG 27,74	PZ / PCS 30	M ² 43,20	KG 852,26
30x60 cm - 11 ^{7/8} "x23 ^{1/2} "	Thick 9 mm	RealUp + StrideUp	PZ / PCS	8	M ² 1,44	KG 27,60	PZ / PCS 32	M ² 46,08	KG 903,36
Decoro Rilievo 3D 20x120 cm - 8"x47 ^{1/4} " 40x120 cm - 15 ^{3/4} "x47 ^{1/4} "	Thick 9 mm	RealUp + StrideUp	PZ / PCS	4	M ² 1,44	KG 30,00	PZ / PCS -	M ² -	KG -
Decoro Radio 3D 120x120 cm - 47 ^{1/4} "x47 ^{1/4} "	Thick 9 mm	RealUp + StrideUp	PZ / PCS	2	M ² 1,44	KG 30,00	PZ / PCS -	M ² -	KG -
Listello Tratto 20x120 cm - 8"x47 ^{1/4} "	Thick 6 mm / 9mm	Naturale	PZ / PCS	6	M ² 1,44	KG 19,30	PZ / PCS 30	M ² 43,20	KG 599,06
Muretto 30x30 cm - 11 ^{7/8} "x11 ^{7/8} "	Thick 6 mm	Naturale	PZ / PCS	6	M ² 0,54	KG 7,81	PZ / PCS 60	M ² 32,40	KG 489,08
Muretto 30x30 cm - 11 ^{7/8} "x11 ^{7/8} "	Thick 9 mm	RealUp + StrideUp	PZ / PCS	6	M ² 0,54	KG 10,20	PZ / PCS 60	M ² 32,40	KG 632,00
Mosaico 30x30 cm - 11 ^{7/8} "x11 ^{7/8} "	Thick 9 mm	RealUp + StrideUp	PZ / PCS	12	M ² 1,08	KG 20,62	PZ / PCS 30	M ² 32,40	KG 638,60

IMBALLI MEGA	DESCRIZIONE IMBALLO PACKAGING DESCRIPTION	MQ / KG LASTRA / SLAB	IMBALLO PIENO FULL PACKAGING	IMBALLO VUOTO EMPTY PACKAGING
	CASSA / CRATE L 145 x P 292 x H 35	MQ 3,36	MQ 67,20	
		KG 48,60	KG 1062,00	KG 100,00
	CAVALLETTO / A-FRAME L 75 x P 285 x H 153	MQ 3,36	MQ 147,84	
		KG 48,60	KG 2318,40	KG 180,00
	CASSA LIGHT / LIGHT CRATE L 145 x P 292 x H 27	MQ 3,36	MQ 30,24	
		KG 48,60	KG 527,40	KG 90,00
			PZ 1 / 9	

STUCCHI CONSIGLIATI / RECOMMENDED GROUTS

Colori Colors				
	Bianco Vein Cut / Cross Cut	Beige Vein Cut / Cross Cut	Grigio Vein Cut / Cross Cut	Rosso Vein Cut
Kerakoll	05	21	43	40
Mapei	80% 100 + 20% 110	80% 100 + 20% 132	111	70% 142 + 30% 143

TECHNICAL SPECIFICATIONS PORCELAIN STONEWARE

TECHNISCHE EIGENSCHAFTEN FEINSTEINZEUG / CARACTÉRISTIQUES TECHNIQUES GRES CERAME

CONFORME A NORME / CONFORMING TO STANDARDS / GEMÄSS DEN NORMEN / CONFORMES AUX NORMES
EN 14411 ISO 13006 APPENDICE G GRUPPO BIa UGL CON Ev ≤ 0,5%

CARATTERISTICA TECNICA PHYSICAL PROPERTIES TECHNISCHE DATEN CARACTÉRISTIQUE TECHNIQUE	METODICA DI PROVA TESTING METHOD PRÜFVERFAHREN NORME D'ESSAIS	RIFERIMENTO NORMA REFERENCE STANDARD RÉFÉRENCE NORME STANDARDWERT	VALORE PRODOTTO PRODUCT VALUES PRODUKT WERTE VALEUR PRODUIT
Dimensioni Sizes Abmessungen Dimensions		7cm ≤ N < 15 cm N ≥ 15 cm (mm) (%) (mm)	
		Lunghezza e larghezza - Length and width - Länge und Breite Longueur et largeur	±0.9 ±0.6 ±2.0
		Spessore - Thickness - Stärke - Epaisseur	±0.5 ±5.0 ±0.5
		Rettilinearità spigoli - Linearity - Kantengeradheit - Rectitude des arêtes	±0.75 ±0.5 ±1.5
		Ortogonalità - Wedging - Rechtwinkligkeit - Orthogonalité	±0.75 ±0.5 ±2.0
	Planarità - Warpage - Ebenflächigkeit - Planéité	±0.75 ±0.5 ±2.0	
	Aspetto: percentuale di piastrelle accettabili nel lotto - Appearance: percentage of acceptable tiles, per lot oberflächenbeschaffenheit: prozentsatz der fliesen, die den geforderten eigenschaften entsprechen - Aspect: pourcentage de carreaux acceptables sur la fourniture totale	95 % min. 95 % min.	Rettificato / Rectified Conforme Conforming Erfüllt Conforme
Assorbimento d'acqua % - Water absorption % Wasseraufnahme % - Absorption d'eau %	EN ISO 10545-3	Ev ≤ 0,5%	Conforme - Conforming - Erfüllt - Conforme
Resistenza alla flessione - Modulus of rupture Biegezugfestigkeit - Résistance à la flexion	EN ISO 10545-4	Valore medio 35 N/mm2 min. sp. > = 7,5 mm: min 1300 N sp. < 7,5 mm: min 700 N	Conforme - Conforming - Erfüllt - Conforme
Sforzo di rottura - Breakage resistance Bruchlast - Resistance à la rupture			Conforme - Conforming - Erfüllt - Conforme
Resistenza all'abrasione profonda - Deep abrasion resistance Bestimmung des Widerstandes gegen tiefen Verschleib Résistance à l'abrasion	EN ISO 10545-6	175 mm3 max.	Medio - Average - Mittelwert - Moyenne < 150 mm3
Coefficiente di dilatazione termica lineare - Thermal expansion coefficient - Wärmeausdehnung - Coefficient de dilatation thermique linéaire	EN ISO 10545-8	Valore dichiarato - Declared value - Angegebener Wert - Valeur déclaré	6,8 MK-1
Resistenza agli sbalzi termici - Thermal shock resistance - Temperaturwechselbeständigkeit - Résistance aux écarts de température	EN ISO 10545-9	Test superato in accordo con ISO 10545-1 - Pass according to ISO 10545-1 Test ueberstanden nach ISO 10545-1 - Pv en accord avec norme en 10545-1	* Resistente - Resistant Widerstandsfähig - Résistants
Resistenza al gelo - Frost resistance Frostbeständigkeit - Résistance au gel	EN ISO 10545-12	Test superato in accordo con ISO 10545-1 - Pass according to ISO 10545-1 Test ueberstanden nach ISO 10545-1 - Pv en accord avec norme en 10545-1	* Resistente - Resistant Widerstandsfähig - Résistants
Resistenza a basse concentrazioni di acidi e alcali Resistance to low concentrations of acids and alkali - Beständigkeit gegen schwach konzentrierte säuren und laugen - Résistance à des basses concentrations d'acides et bases		Valore dichiarato - Declared value - Angegebener Wert - Valeur déclaré	* Resistente - Resistant Widerstandsfähig - Résistants
Resistenza ad alte concentrazioni di acidi e alcali Resistance to high concentrations of acids and alkali Beständigkeit gegen stark konzentrierte säuren und laugen Résistance à des hautes concentrations d'acides et bases	EN ISO 10545-13	Valore dichiarato - Declared value - Angegebener Wert - Valeur déclaré	* Resistente - Resistant Widerstandsfähig - Résistants
Resistenza ai prodotti chimici di uso domesticow e agli additivi per piscina - Resistance to domestic chemicals and additives for swimming pools - Beständigkeit gegen chemische haushaltsreinerer und zusatzstoffe für schwimmbäder - Résistance aux prod. chimiques d'usage domestique et additifs pour piscines		UB min.	UA
Resistenza alle macchie di piastrelle non smaltate naturali Stain resistance of unglazed matte porcelain - Fleckenbe- ständigkeit von unglasierten natur - Fliesen Résistance aux taches des carreaux non émaillés naturel	EN ISO 10545-14	Valore dichiarato - Declared value - Angegebener Wert - Valeur déclaré	* Resistente - Resistant Widerstandsfähig - Résistants
	DIN 51130		Valore disponibile a richiesta Value available upon request Wert auf Anfrage verfügbar Valeur disponible sur demande
Resistenza alla scivolosità Slip resistance Rutschfestigkeit Résistance au dérapage	DIN 51097	Dove richiesto - If needed - Nach anforderung - Si demande	Valore disponibile a richiesta Value available upon request Wert auf Anfrage verfügbar Valeur disponible sur demande
	B.C.R.A. - D.M.236/89 ANSI A326.3 D COF		> 0,40 Dry / > 0,40 Wet ≥ 0,42 Wet

* Si raccomanda di consultare Project Department per le indicazioni necessarie al corretto utilizzo.
It's advisable to refer Project Department for all necessary guidelines to a correct use.
Zur korrekten Anwendung wird empfohlen unsere Project Department zu kontaktieren.
Merci de consulter notre Project Department pour les indications à un usage correct.



QUALITY SYSTEM MANAGEMENT - ISO 9001

La certificazione UNI ISO 9001 2015 è riconosciuta a livello internazionale e rappresenta una garanzia di eccellenza e qualità del proprio sistema di gestione. ITALGRANITI GROUP ha deciso di intraprendere spontaneamente questo importante percorso adottando un insieme di regole, responsabilità e controlli per **migliorare l'efficienza dei processi e la soddisfazione del cliente, accrescere la propria competitività e mantenere la conformità ai più alti standard qualitativi.**

UNI ISO 9001 2015 certification is internationally recognised and represents a guarantee of the excellence and quality of the management system. ITALGRANITI GROUP decided of its own accord to undertake this important process, adopting a set of rules, responsibilities and checks to **improve the efficiency of processes and customer satisfaction, to boost its competitiveness and maintain compliance with the highest quality standards.**



CARBON MANAGEMENT - ISO 14064-1

La certificazione ISO 14064-1 permette alle organizzazioni di quantificare le proprie emissioni di GHG al fine di attuare delle politiche di Carbon Management e comunicare il proprio impegno in tema di sostenibilità ai propri stakeholder. Italgraniti Group ha intrapreso un percorso di rendicontazione delle proprie emissioni e rimozioni di gas ad effetto serra (GHGs). Lo studio intende rispondere ad una esigenza orientata, non solo alla conoscenza della propria Impronta di Carbonio ma anche all'individuazione di possibili strategie e azioni volte a ridurre le emissioni di GHG. Questa importante certificazione testimonia l'approccio pro-attivo del Gruppo e la capacità di fornire dati coerenti ed affidabili sulla propria Carbon Footprint.

ISO 14064-1 certification allows organisations to quantify their GHG emissions to implement carbon management policies and communicate their sustainability commitment to their stakeholders. Italgraniti Group started a reporting path on their greenhouse gases (GHG) emissions and removal. The study intends to respond to a need geared not only towards knowing their own Carbon Footprint but also towards identifying possible strategies and actions aimed to reducing GHG emissions. This important certification proves the Group proactive approach and the ability to provide consistent and reliable data on their Carbon Footprint.

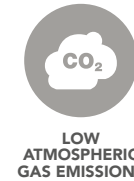

SAFETY SYSTEM MANAGEMENT - ISO 45001

La salute e il benessere dei lavoratori sono interessi primari per ITALGRANITI GROUP. L'ottenimento della **certificazione UNI ISO 45001** rafforza una cultura d'impresa che vede la sicurezza non solo come a un adempimento normativo, ma come parte essenziale dei processi lavorativi. La normativa è **uno strumento necessario per generare un nuovo modello di competitività sostenibile** che possa migliorare la crescita di tutte le performance aziendali.

The health and wellbeing of employees are crucial priorities for ITALGRANITI GROUP. The attainment of **UNI ISO 45001 certification** strengthens a business culture that sees safety not simply as a question of regulatory compliance, but as an essential part of working processes. Regulation is a necessary tool for generating **a new model of sustainable competitiveness** that can improve company performance across the board.



ECOVADIS

Italgraniti Group ha ottenuto il riconoscimento della Medaglia Silver Ecovadis, una delle più importanti piattaforme internazionali di rating della eco-sostenibilità. EcoVadis mira a migliorare le pratiche ambientali e sociali delle aziende sfruttando l'influenza delle catene logistiche globali. È una delle più importanti piattaforme internazionali di rating dell'eco-sostenibilità e gestisce la prima piattaforma collaborativa che permette alle aziende di monitorare la performance di sostenibilità dei loro fornitori, in 150 settori e in 110 Paesi. Attribuisce un punteggio che consente alla singola azienda una grande visibilità nei confronti di una vasta platea di potenziali clienti, sempre più interessati ai livelli di sostenibilità della supply chain. Il modello di valutazione si basa su standard riconosciuti a livello mondiale come GRI (Global Reporting Initiative), UNGC (Patto Mondiale delle Nazioni unite), ISO 26000 ed è presidiato da un comitato scientifico internazionale: consiste nel verificare, attraverso un questionario, le performance del fornitore in relazione a 4 macro-ambiti:

- Ambiente
- Lavoro e diritti umani
- Etica
- Acquisti sostenibili.

Italgraniti Group was awarded the Silver Ecovadis Medal, one of the most important international eco-sustainability rating platforms. EcoVadis aims to improve environmental and social practices of companies by harnessing the influence of global logistics chains. It is one of the leading international eco-sustainability rating platforms and operates the first collaborative platform that allows companies to monitor the sustainability performance of their suppliers, in 150 sectors and in 110 countries. It assigns a score that gives the individual company high visibility to a wide audience of potential customers, who are increasingly interested in the sustainability levels of the supply chain. The evaluation model is based on globally recognised standards such as GRI (Global Reporting Initiative), UNGC (United Nations Global Compact), ISO 26000 and is overseen by an international scientific committee: it consists of verifying, by means of a questionnaire, the supplier's performance in relation to 4 macro-themes:

- Environment
- Labour and human rights
- Ethics
- Sustainable procurement.



ENVIRONMENTAL MANAGEMENT - ISO 14001 - EMAS

Italgraniti Group opera in conformità alle normative ambientali previste dalla certificazione ISO 14001 e del regolamento EMAS, ottenuta da oltre 10 anni. La certificazione europea EMAS (Eco-Management and Audit Scheme) misura e controlla il ridotto impatto sull'ambiente dei siti produttivi, attraverso un sistema di gestione ambientale basato su rigorosi parametri.

Italgraniti Group conforms with the environmental regulations envisaged by the ISO 14001 certification and by the EMAS certification, obtained more than 10 years ago. The European EMAS (Eco-Management and Audit Scheme) certification measures and controls the reduced environmental impact of production sites, through an environmental management system based on strict parameters.

ITALGRANITI GROUP CONTRIBUISCE ALL'EFFICIENZA ENERGETICA ATTRAVERSO:

- 100% di riciclaggio delle acque utilizzate
- 100% riciclo degli scarti crudi e cotti
- 100% riciclo del packaging e dei pallet

ITALGRANITI GROUP CONTRIBUTES TOWARDS ENERGY EFFICIENCY THROUGH:

- 100% recycling of waters used
- 100% recycling of unfired and fired waste
- 100% recycling of packaging and pallets



EPD

L'EPD (Environmental Product Declaration, dichiarazione ambientale di prodotto) è un documento sintetico che traccia il profilo delle prestazioni ambientali del nostro prodotto e che permette di comunicare informazioni oggettive, confrontabili e credibili al riguardo, senza esprimere criteri di valutazione, preferibilità o livelli minimi da rispettare; permette così, a chi lo consulta, di compiere una scelta consapevole e correttamente informata. Quest'anno ITALGRANITI GROUP ha pubblicato il documento con i dati delle proprie attività su www.environdec.com, sito dell'International EPD System, il primo e più lungo programma EPD al mondo.

The EPD (Environmental Product Declaration) is a concise document that outlines the environmental performance profile of our product and allows us to communicate objective, comparable and credible information in this regard, without expressing evaluation, preferability or minimum levels to be respected; it thus allows those who read it to make a conscious and correctly informed choice. This year ITALGRANITI GROUP published its activity data on www.environdec.com, the website of the International EPD System, the world's first and longest running EPD program.



100% WATER CONSUMPTION SAVINGS



100% RECYCLING OF UNFIRED WASTE



100% RECYCLING OF FIRED WASTE



100% RECYCLED PACKAGING



100% RECYCLED PALLETS



HPD

Italgraniti Group ha adottato lo standard collaborativo HPD Dichiarazioni di Salubrità di Prodotto (Health Product Declarations), per comunicare in modo trasparente il contenuto dei propri materiali e il relativo impatto sulla salute. Grazie all'HPD, i nostri prodotti contribuiscono all'ottenimento di crediti LEED® e WELL™.

Italgraniti Group has adopted the HPD (Health Product Declarations) collaborative standard to communicate the contents of its materials and the related impact on health in a transparent manner. Thanks to HPD, our products contribute towards obtaining LEED® and WELL™ credits.



LEED CERTIFICATION

I prodotti di ITALGRANITI GROUP rispondono ai requisiti richiesti dalle certificazioni LEED. I crediti LEED forniscono a tutte le parti interessate gli strumenti necessari per calcolare in modo oggettivo l'impatto di uno stabile in termini di sostenibilità ambientale. Il sistema si basa sull'attribuzione, per ciascuno dei requisiti caratterizzanti l'eco-compatibilità di un edificio, di crediti che, sommati tra loro, danno il livello di certificazione ottenuto: più alto è, più cresce il valore competitivo dell'immobile sul mercato.

I nostri prodotti non rilasciano sostanze tossiche e non contribuiscono all'effetto isola di calore; inoltre, escono da uno stabilimento dotato di sistema di gestione ambientale certificato. Per realizzarli viene utilizzata una percentuale certificata di materiale riciclato superiore al 20% (materiale pre-consumo). Questa certificazione è stata rilasciata da Bureau Veritas Italia S.p.A.

ITALGRANITI GROUP's products meet the requirements of LEED certifications. LEED credits provide all interested parties with the necessary tools to objectively calculate the impact of a building in terms of environmental sustainability. The system is based on the attribution - for each of the requirements characterising the eco-compatibility of a building - of credits that, added together, give the level of certification obtained: the higher it is, the greater the competitive value of the building on the market.

Our products do not release toxic substances and do not contribute to the heat island effect; moreover, they come from a plant with a certified environmental management system. A certified percentage of more than 20% recycled material (pre-consumer material) is used to manufacture them. This certification was issued by Bureau Veritas Italia S.p.A.



Italgraniti Group è membro del Green Building Council Italia, organizzazione che promuove la cultura e la pratica dell'edilizia sostenibile in un contesto che rispetti le esigenze dell'uomo, della collettività e dell'ambiente.

Italgraniti Group is a member of the Green Building Council Italia, an organisation that promotes the culture and practice of sustainable construction in a context that respects the needs of mankind, of the collective whole and of the environment.

BREEAM®

BREEAM® (Building Research Establishment Environmental Assessment Method), sviluppato nel 1990 dal BRE Global, è uno dei principali sistemi al mondo utilizzato per misurare le prestazioni ambientali e di sostenibilità degli edifici nuovi ed esistenti. La valutazione BREEAM® utilizza una gamma di indicatori e criteri di sostenibilità per valutare le prestazioni dell'edificio coprendo diverse tematiche ambientali: energy e risorse idriche, salute e benessere, inquinamento, trasporti, materiali, rifiuti, ecologia e processi di gestione. Tutte le collezioni Italgraniti contribuiscono al raggiungimento dei crediti BREEAM®.

BREEAM® (Building Research Establishment Environmental Assessment Method), which was developed in 1990 by BRE Global, is one of the main systems in the world used to measure the environmental and sustainability performance of new and existing buildings. The BREEAM® assessment uses a range of indicators and sustainability criteria to assess the performance levels of a building, covering several environmental topics: energy and water resources, health and wellbeing, pollution, transport, materials, waste, environmental awareness and management processes. All Italgraniti collections contribute towards obtaining BREEAM® credits.

WELL™

WELL™ Building Standard (WELL™) è il primo sistema di rating per l'edilizia sostenibile che consente di misurare, certificare e monitorare le caratteristiche dell'edificio che hanno un impatto sulla salute e sul benessere degli occupanti. Il WELL™ fornisce un percorso per integrare e misurare i temi della salute umana e del benessere nella progettazione, costruzione e gestione di edifici. Per ottenere la certificazione WELL™ Building Standard™, l'edificio deve essere sottoposto a un processo che comprende una valutazione in loco e una verifica delle prestazioni da parte di un certificatore abilitato. Tutte le collezioni Italgraniti contribuiscono al raggiungimento dei crediti WELL™.

WELL™ Building Standard (WELL™) is the number one rating system for sustainable construction designed to measure, certify and monitor the features of the building, which have an impact on the health and wellbeing of its occupants. WELL™ provides a path to integrate and measure topics of human health and wellbeing in the design, construction and management of buildings. To obtain the WELL™ Building Standard™ certification, the building must undergo a process which includes an on-site assessment and an inspection of performance levels by a qualified certifier. All Italgraniti collections contribute towards obtaining WELL™ credits.

CAM ISO 14021

I Criteri Ambientali Minimi (CAM) sono i requisiti ambientali ed ecologici definiti dal Ministero dell'Ambiente. Con decreto 23 giugno 2022 il Ministero della Transizione Ecologica ha disposto la loro revisione (Criteri ambientali minimi per l'affidamento del servizio di progettazione ed esecuzione dei lavori di interventi edilizi). I CAM mirano a facilitare l'inserimento di requisiti di eco-sostenibilità nelle gare d'appalto per interventi pubblici. L'obiettivo è quello di stimolare acquisti che minimizzino l'uso di risorse naturali e il consumo di energia, che contribuiscano inoltre alla diffusione di fonti rinnovabili, riducano la produzione di rifiuti, le emissioni inquinanti nell'aria, nell'acqua e nel suolo ed che eliminino le sostanze ambientalmente pericolose. Grazie ad un sistema di gestione ambientale sostenibile, alla certificazione EPD e in accordo con lo standard internazionale ISO 14021, Italgraniti contribuisce ad un'edilizia di qualità e prestazioni al di sopra della media di settore.

The Minimum Environmental Criteria (CAM) are the environmental and ecological requirements defined by the Italian Ministry of the Environment. By decree of 23 June 2022, the Ministry of Ecological Transition ordered their revision (Minimum Environmental Criteria for the awarding of design and execution services for building works). CAM aims to facilitate the inclusion of eco-sustainability requirements in tenders for public operations. The aim is to stimulate purchases that minimise the use of natural resources and energy consumption levels, which also contribute towards the spread of renewable sources, reducing waste production, polluting emissions into the air, water and soil, and which eradicate environmentally hazardous substances. Thanks to a sustainable environmental management system, to the EPD certification and in accordance with international standard ISO 14021, Italgraniti contributes towards quality construction with performance levels above the industry average.



ONGREENING

Ongreening.com fornisce informazioni dettagliate sulla conformità e il contributo dei prodotti Italgraniti Group ai principali sistemi di certificazione della sostenibilità degli edifici (LEED®, BREEAM®, WELL™, CAM ed altri).

Ongreening.com provides detailed information about the conformity and contribution of Italgraniti Group products to the main building sustainability certification systems (LEED®, BREEAM®, WELL™, CAM and others).

FOR MORE INFO VISIT
ONGREENING.COM



Il prestigioso marchio d'origine Ceramics of Italy contrassegna solamente i prodotti realizzati in Italia, che rappresentano i valori appartenenti all'industria ceramica da decenni.

ITALGRANITI GROUP sostiene il codice etico di Confindustria Ceramica che, **dalla produzione 100% Made in Italy alla responsabilità sociale e ambientale, promuove una politica industriale seria e trasparente.**

Ceramics of Italy is the certified brand of origin which exclusively marks all products fully manufactured in Italy representing the decades old values system of the Italian Ceramic Industry.

We support all those values promoted by the Confindustria Ceramica code of ethics, **from 100% Italian production to social and environmental responsibility.**



Portiamo con orgoglio in tutto il mondo materiali che esprimono al meglio la cultura estetica, l'eccellenza stilistica e tecnica del Made in Italy.

Sul mercato internazionale, il nostro nome è sinonimo di grès porcellanato dalle altissime prestazioni tecniche ed estetiche e attraverso la trasformazione di materie prime di assoluta qualità otteniamo progetti ceramici capaci d'interpretare le molteplici esigenze di un mondo in costante evoluzione.

Around the world, we proudly promote materials that best express that Made in Italy aesthetic, style and technical excellence.

On the international market, our name is synonymous with porcelain stoneware that offers extremely high technical and aesthetic performance. We transform top quality raw materials into ceramic projects able to interpret the many requirements of a continuously evolving world.

ART DIRECTION

Andrea Parisio, Giuseppe Pezzano

GRAPHIC DESIGN

VZNstudio
Nicola Iannibello, Sonia Mion

RENDER

suprema unlimited reality

STYLING

Alessandra Vigani

TEXT

Valeria Cristofani

Cod. JCATTR
Cessione Gratuita - Materiale non destinato alla vendita

Italgraniti Group S.p.A.

Via Radici in Piano 355
41043 Formigine - Modena - Italy
Tel +39 059 888411
Fax +39 059 848808
www.italgranitigroup.com
info@italgranitigroup.com
project.department@italgranitigroup.com

Flagship Store

Via Statuto 21
20121 - Milano - Italy
Tel +39 02 84567687
milano@italgranitigroup.com

 **ITALGRANITI**
SUPERIOR ITALIAN SURFACES



Cod. JCATTR

Cessione Gratuita - Materiale non destinato alla vendita

Certified



Corporation