

Subway Collection Made in USA

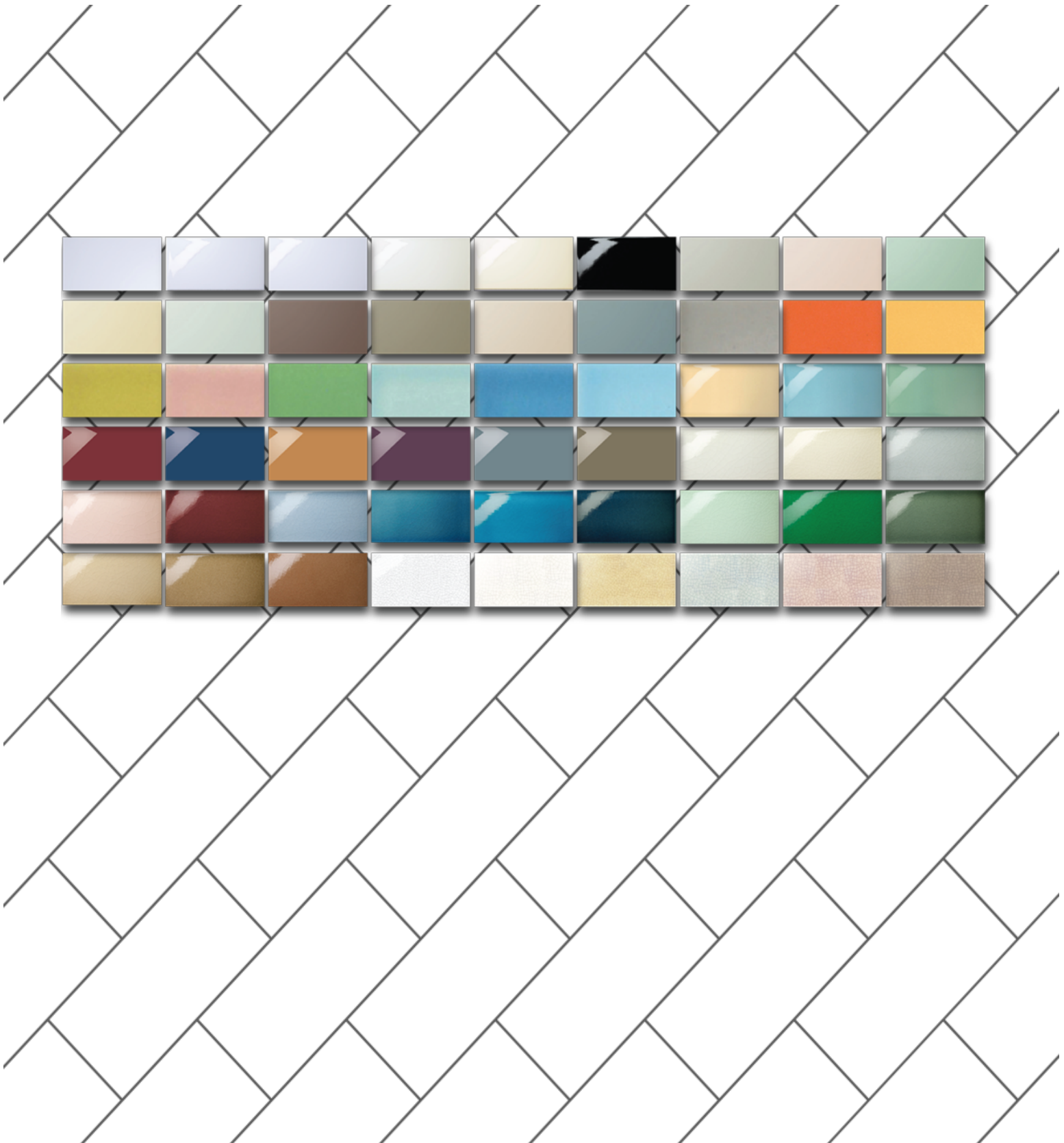

Crackle Glazes



Gloss Glazes



10 White Gloss	14 Avalon Gloss
12 Bianco Gloss	11 Bone Gloss
35 Cameo Gloss	37 Primrose Gloss
34 Julip Gloss	36 Celeste Gloss
13 Gray Gloss	74 Concorde Blue Gloss
87 Artichoke Gloss	86 Earle Gray Gloss
84 Apricot Gloss	85 Eggplant Gloss
83 Pomegranate Gloss	99 Black Gloss

Satin Glazes





22FT00 2" x
2" Field Tile

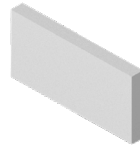

24FT00 2-1/8" x
4-1/4" Field Tile

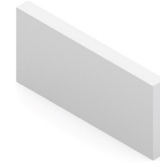

24FT01 2" x
4" Field Tile

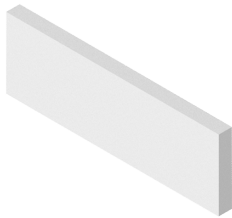

26FT00 2" x
6" Field Tile



33FT00 3" x
3" Field Tile

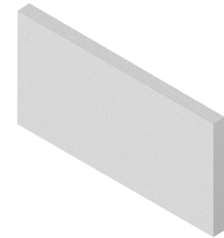

36FT00 3" x
6" Field Tile

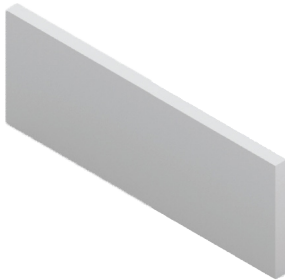

39FT00 3" x
9" Field Tile



3CFT00 3" x
12" Field Tile



44FT00 4-1/4" x
4-1/4" Field Tile

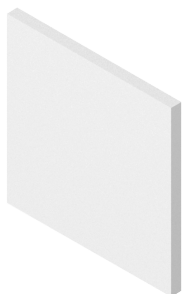

66FT00 6" x
6" Field Tile



69FT00 6" x
9" Field Tile

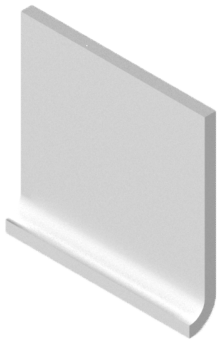

66CB00 6" x 6" Sanitary
Cove Base moulding



66CB2L 6" x 6"
Sanitary Cove Base
end stop - left

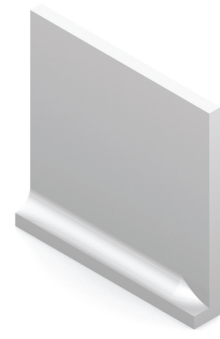

66CB2R 6" x 6"
Sanitary Cove Base
end stop - Right

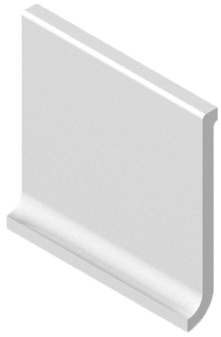

66SC00 6" x 6" Shoulder
Cove Base moulding

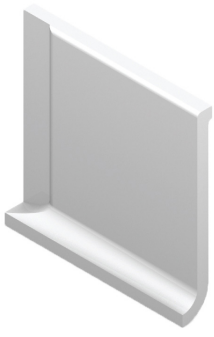

66SC2L 6" x 6" Shoulder
Cove base endstop - left



66SC2R 6" x 6" Shoulder
Cove base endstop -
right



66RB00 6" x 6" Roman
Base moulding



06RB01 6" Roman
Cove Base moulding



06CB01 6" Sanitary
Cove Base - outside
corner



06SC01 6" Shoulder
Cove Base - outside
corner



06SC02 6" Shoulder
Cove Base - inside
corner

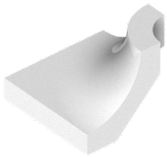

22EC01 2" x 2" Ellis
Cove
Base - outside corner
[for use with radius bullnose or
quarter round trims]



22EC02 2" x 2" Ellis
Cove
Base - inside corner [for
use with radius cove or
quarter cove trims]



22EC03 2" x 2" Ellis
Cove
Base - inside corner [for
use with non-radius inside
corner treatment]



22EC04 2" x 2" Ellis
Cove
Base - inside corner [for
use with Ellis Cove as vertical
cove trim]

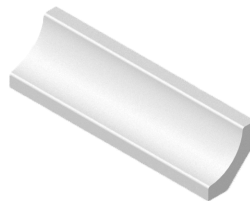

26EC00 2" x 6" Ellis
Cove
Base moulding [1-3/8" total
piece pro-file width, protrudes 1"
when filed -in]



06LN00 1/2" X
6" Flat Accent
Liner



16LN00 1" x
6" Flat Accent
Liner

Surface Trims



06LN01 1/2" x 6"
Flat Liner - surface
bullnose



16LN01 1" x 6"
Flat Liner -
bullnose

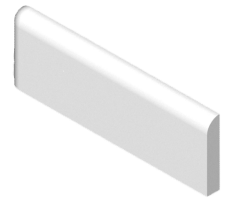

26DB26 2" x 6"
Bullnose Down Corner
- left

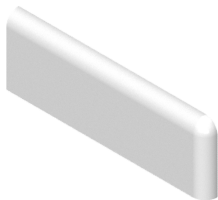

26DB62 2" x 6"
Bullnose Down Corner -
right

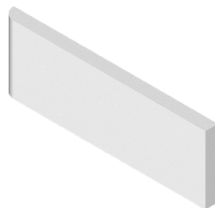

26SB02 2" x 6"
Bullnose - short

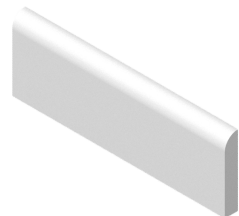

26SB06 2" x 6"
Bullnose - long



33IB33 3" x 3"
Inside Corner
Bullnose



33DB33 3" x 3"
Down Corner
Bullnose

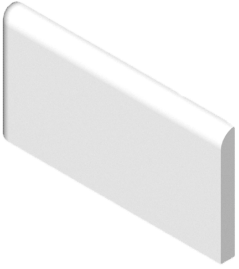

36DB36 3" x 6"
Bullnose Down Corner
- left



36DB63 3" x 6"
Bullnose Down Corner -
right

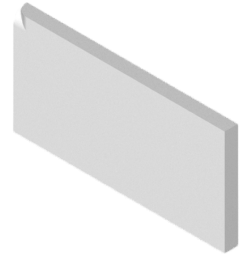

36IB36 3" x 6"
Inside Corner Bullnose
- left

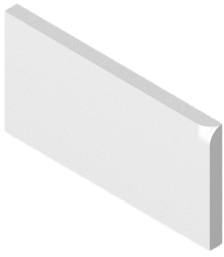

36IB63 3" x 6"
Inside Corner Bullnose -
right



36SB03 3" x 6" Bullnose
- short

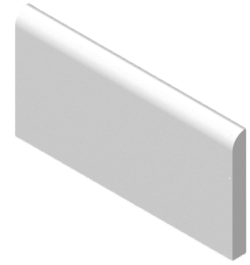

36SB06 3" x 6"
Bullnose - long

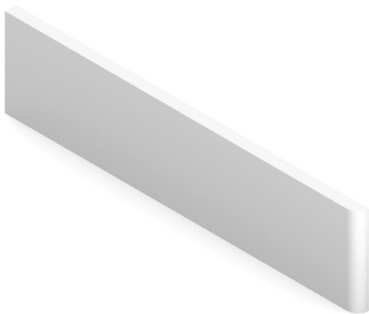

3CSB03 3" x 12"
Bullnose - short

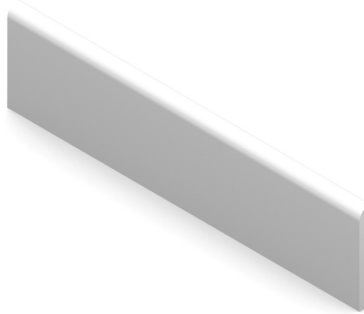

3CSB06 3" x 12"
Bullnose - long

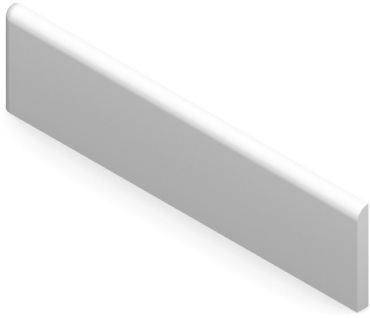

3CDB3C 3" x 12" Down
Corner - left

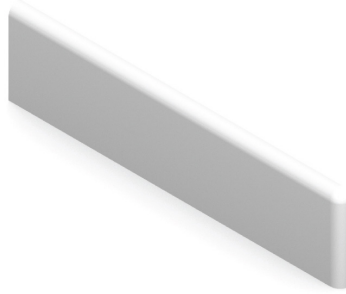

3CDBC3 3" x 12" Down
Corner - right

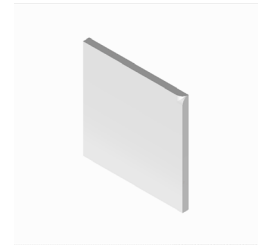

44DB44 4-1/4" x 4-1/4"
Down Corner Bullnose



44IB44 4-1/4" x 4-1/4" Up
Corner Bullnose



44SB04 4-1/4" x 4-1/4"
Surface Bullnose

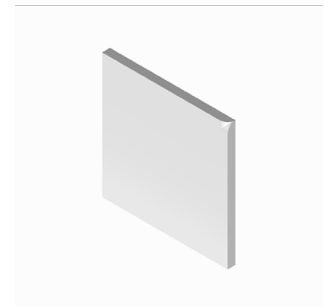

66DB66 6" x 6" Down
Corner Bullnose



66IB66 6" x 6"
Bullnose Inside
Corner



66SB06 6" x
6" Surface
Bullnose

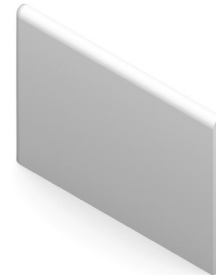

69DB69 6" x 9"
Down Corner Bullnose
- left



69DB96 6" x 9"
Down Corner Bullnose -
right

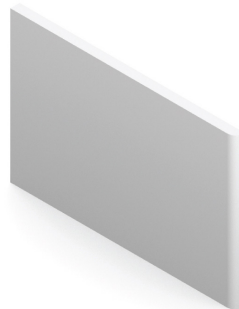

69SB06 6" x
9" Bullnose -
short

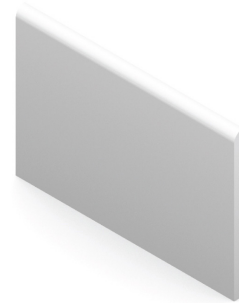

69SB09 6" x
9" Bullnose -
long

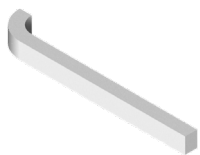

06RB00 1/2" x 6"
Radius Bullnose - short
trim



06RC00 1/2" x 6"
Radius Cove - short
trim



16RB01 1" x 6"
Radius Bullnose - short
trim



16RC01 1" x 6"
Radius Cove - short
trim



22RD22 2" x 2"
Radius Down
Corner



22RU22 2-1/2" x
2-1/2" Full Radius Up
Corner



22SU22 2" x 2"
Square Radius Up
Corner



23RB02 2" x 3-3/4" Radius
Bullnose



23RC02 2" x 3-3/4"
Radius Cove

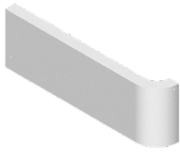

26RB02 2" x 6" Radius Bullnose

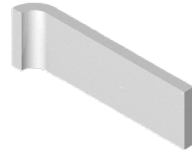

26RC02 2" x 6" Radius Cove



33RB03 3" x 3-3/4" Radius Bullnose



33RC03 3" x 3-3/4" Radius Cove



36RB03 3" x 6" Radius Bullnose - short trim



36RC03 3" x 6" Radius Cove - short



36RB06 3" x 6" Radius Bullnose



36RC06 3" x 6" Radius Cove



36RC36 3" x 6" Radius Cove Down Corner - left



36RC63 3" x 6" Radius Cove Down Corner - right

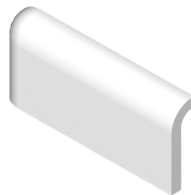

36RD36 3" x 6" Radius Down Corner - left



36RD63 3" x 6" Radius Down Corner - right



44RB04 4-1/4" x 4-1/4" Radius Bullnose



44RC04 4-1/4" x 4-1/4" Radius Cove



44RC44 4-1/4" x 4-1/4" Radius Cove Corner



44RD44 4-1/4" x 4-1/4" Radius Down Corner - right



44RU44 4-1/4" x 4-1/4" Radius Up Corner



44SU44 4-1/4" x 4-1/4" Square Up Corner



66RB06 6" x 6" Radius Bullnose



66RC06 6" x 6" Radius Cove



66RC66 6" x 6" Radius Cove Corner

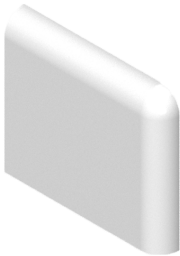

66RD66 6" x 6" Radius Down Corner



66RU66 6" x 6" Radius Up Corner

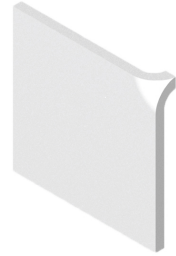

66SU66 6" x 6" Square Up Corner



00QC01
Quarter Cove - 3-way
corner

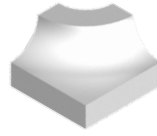

00QC02
Quarter Cove - outside
corner



00QR01
Quarter Cove - 3-way
corner



00QR02
Quarter Cove - inside
corner



02QR01
2" Quarter Round
Beak



06MC02 6" Quarter
Cove / Mud Cap inside
corner



06QC00
6" Quarter Cove



06QC01 6" Quarter Cove
Beak / Sanitary Cove Base -
inside corner



06QC02 6" Bullnose
Quarter Cove - inside
corner



06QR00
6" Quarter Round

06QR01
6" Quarter Round
Beak

06QR02
6" Bullnose Quarter
Round

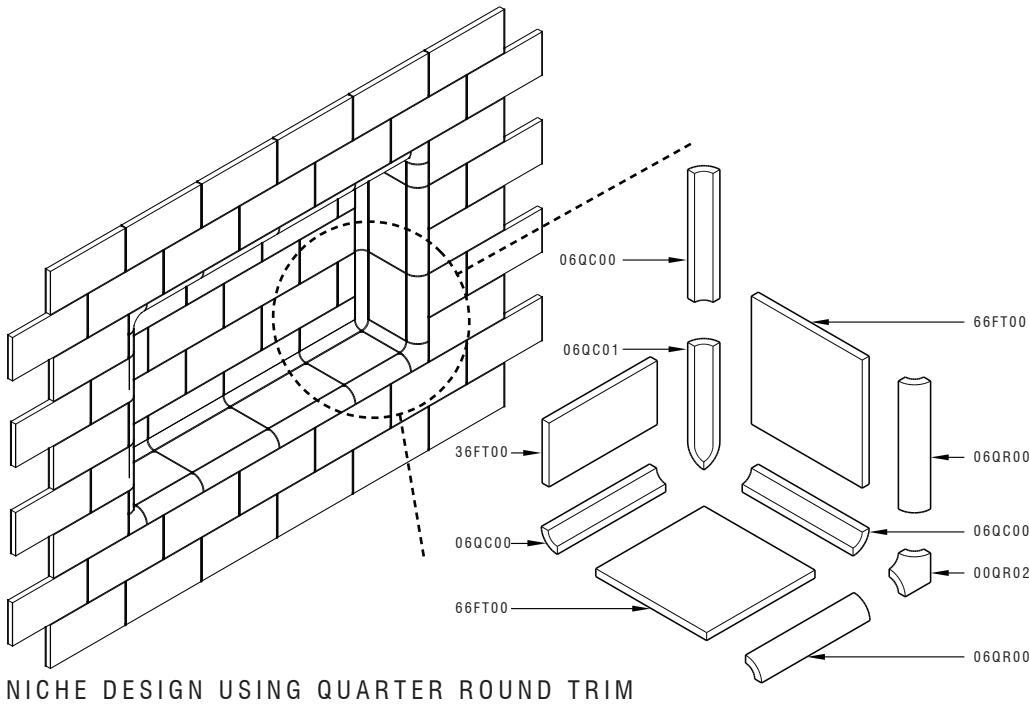

NICHE DESIGN USING QUARTER ROUND TRIM

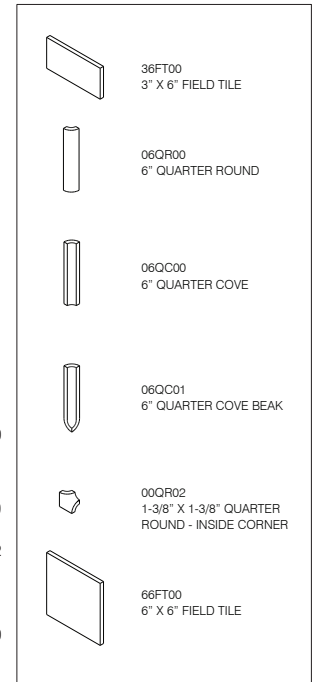

SCHEDULE OF TILES



02MC02 2" Mud Cap - inside corner

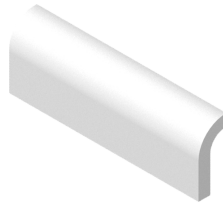

26MC00 2" x 6" Mud Cap Moulding

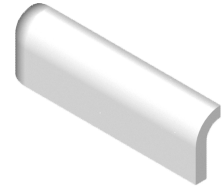





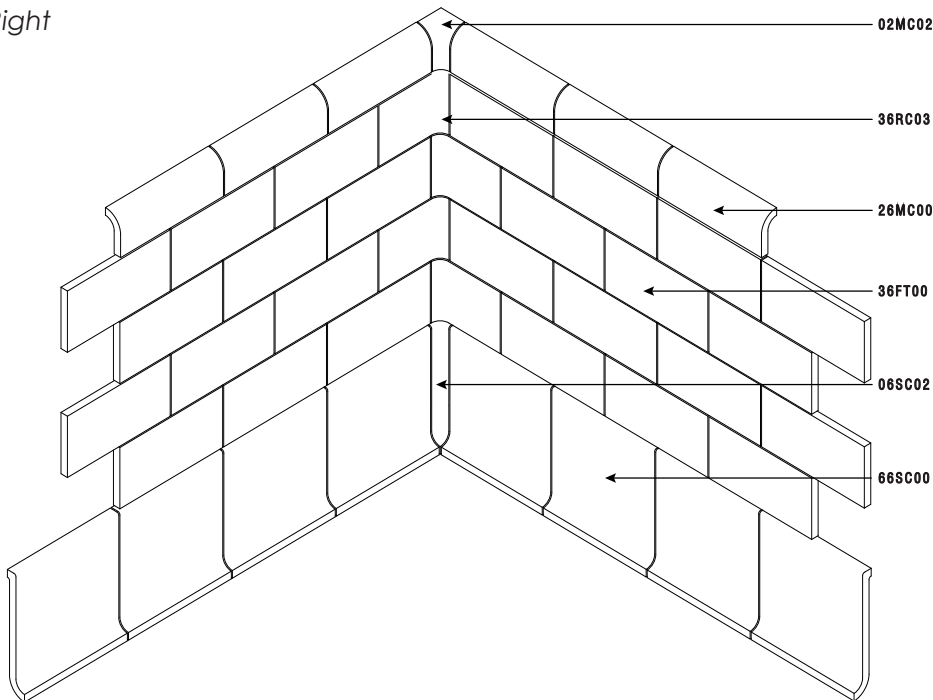

26RD26 2" x 6" Left Radius Down



26RD62 2" x 6" Right Radius Down



IN-CORNER WITH MUD CAP & SHOULDER COVE BASE

	36FT00 3" X 6" FIELD TILE
	36RC03 3" X 6" RADIUS BULLNOSE
	26MC00 2" X 6" MUD CAP
	02MC02 2" MUD CAP INSIDE CORNER
	06SC00 6" X 6" SHOULDER COVE BASE MOULDING
	66SC00 6" SHOULDER COVE BASE INSIDE CORNER

SOME TILE MAY HAVE BEEN CUT TO FIT *
SCHEDULE OF TILES

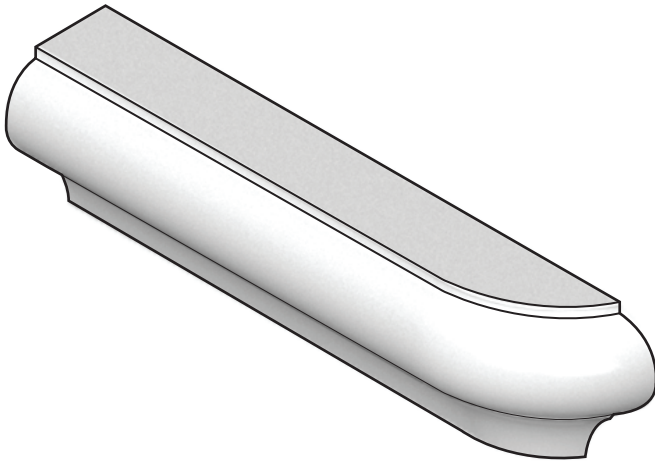

STANDARD P-CAP

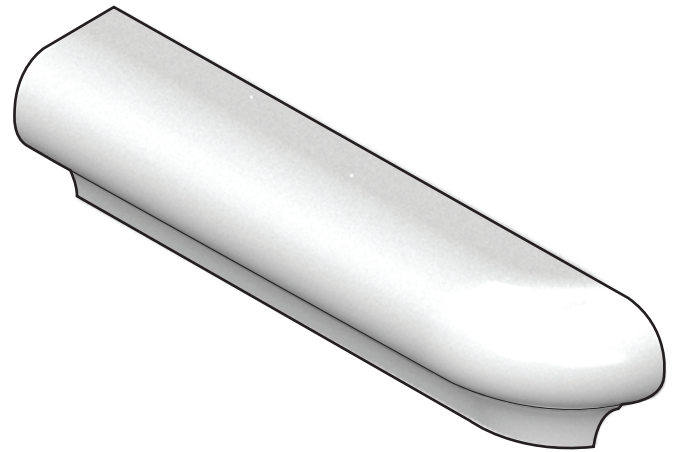

SMOOTH P-CAP

vs.

(All P-Cap styles are available in both Standard and Smooth)



11PC07 2" x 2"
P-cap Moulding - frame
outside corner

11PS07 (smooth)

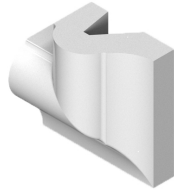

11PC08 2" x 2" P-cap
Frame Corner - inside [for
transitioning wainscot
vertically]

11PS08 (smooth)



16PC00 1-1/2" X 6" P-
cap Moulding

16PS00 (smooth)



16PC1L 1-1/2" x 6" P-
cap Conventional
Outside Corner Return -
left

16PS1L (smooth)



16PC1R 1-1/2" x 6" P-
cap Conventional
Outside Corner Return -
right

16PS1R (smooth)

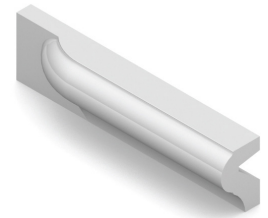

16PC2L 1-1/2" x 6" P-
cap End Stop - left

16PS2L (smooth)

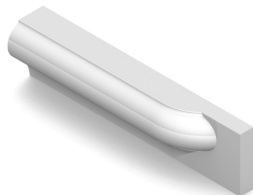

16PC2R 1-1/2" x 6" P-
cap End stop - right
[flat edge not glazed]

16PS2R (smooth)



16PC3L 1-1/2" x 6" P-cap
Inside Corner- left [for use
with quarter cove or
radius cove trims]

16PS3L (smooth)

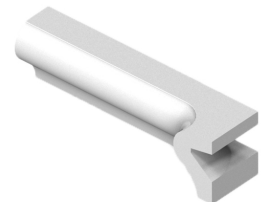

16PC3R 1-1/2" x 6" P-
cap In-side Corner - right
[for use with quarter
cove or radius cove trims]

16PS3R (smooth)

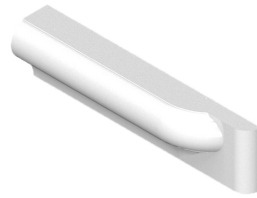

16PC4L 1-1/2" x 6" P-cap Bullnose Stop - left [for use with surface trim only] **16PS4L (smooth)**

16PC4R 1-1/2" x 6" P-cap Bullnose Stop - right [for use with surface trim only] **16PS4R (smooth)**

16PC6L 1-1/2" X 6" P-cap Radius Outside Corner Return **16PS6L (smooth)**



16PC6R 1-1/2" x 6" P-cap Radius Outside Corner Return - right

16PS6R (smooth)





22BX07 2" x 2" Box
Cap Frame Corner -
outside



22BX08 2" x 2" Box
Cap - inside corner

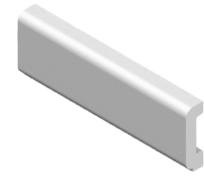

26BX00 2" X 6" Box
Cap Moulding



26BX1L 2" x 6" Box
Cap Conventional
Outside Corner Return
- left



26BX1R 2" x 6" Box
Cap Conventional
Outside Corner Return -
right

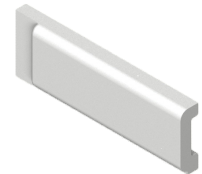

26BX2L 2" x 6" Box Cap
End Stop - left

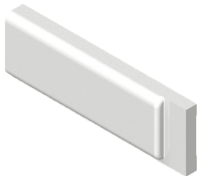

26BX2R 2" x 6" Box Cap
End Stop - right

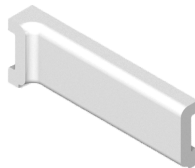

26BX3L 2" x 6" Box Cap
Inside Corner - left

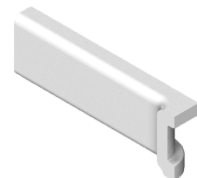

26BX3R 2" x 6" Box Cap
Inside Corner - right

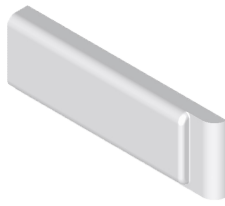
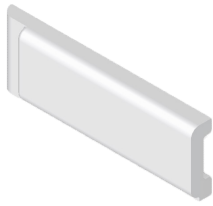

26BX4L 2" x 6" Box Cap
Bullnose Stop - left

26BX4R 2" x 6" Box
Cap Bullnose Stop -
right





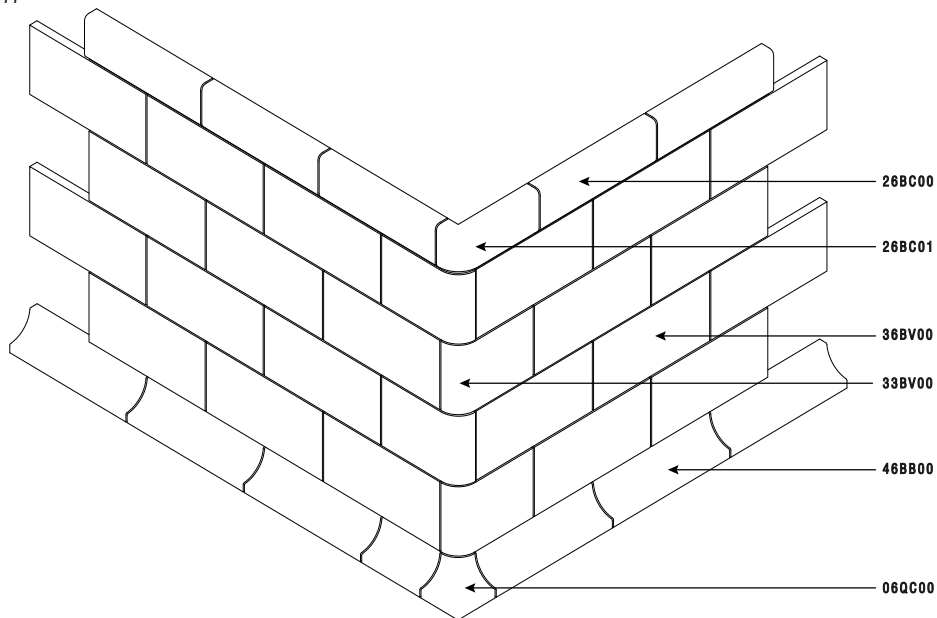

26BX6R 2" x 6" Box
Cap Radius Outside
Corner Return - right



26BX6L 2" X 6" Box
Cap Radius Outside
Corner Return - left



OUT-CORNER WITH BOX CAP & ELLIS COVE BASE

	36FT00 3" X 6" FIELD TILE
	33RB03 3" X 3" RADIUS BULLNOSE
	26BX00 2" X 6" BOX CAP MOULDING
	26BX6L 2" X 6" BOX CAP RADIUS OUTSIDE CORNER RETURN
	26EC00 2" X 6" ELLIS COVE BASE MOULDING
	22EC01 2" X 2" ELLIS COVE BASE OUTSIDE CORNER

SOME TILE MAY HAVE BEEN CUT TO FIT *

SCHEDULE OF TILES

Box Cap Extended moulding (for traditional thick-set)

* Extended Box cap mouldings protrude a 1/2" more than conventional versions

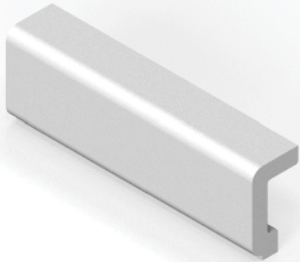

26BE00 2"x 6" Box Cap extended moulding



26BE1L 2"x 6" Box Cap extended conventional corner return - left [for use with radius bullnose or quarter round trims]



26BE1R 2"x 6" Box Cap extended conventional corner return - right [for use with radius bullnose or quarter round trims]

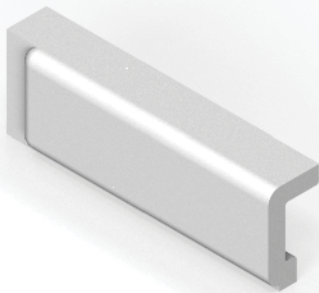

26BE2L 2"x 6" Box Cap extended end stop - left

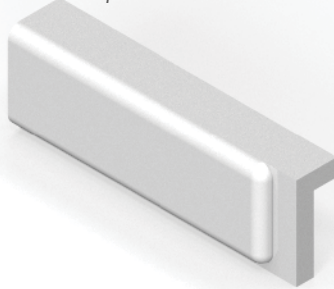

26BE2R 2"x 6" Box Cap extended end stop - right

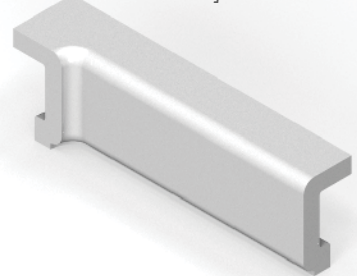

26BE3L 2"x 6" Box Cap extended inside corner - left [for use with radius cove or quarter cove trims]

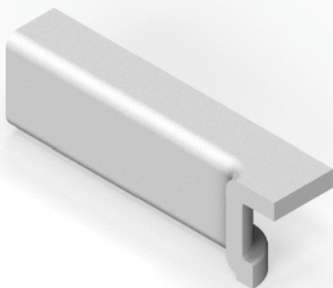

26BE3R 2"x 6" Box Cap extended inside corner - right [for use with radius cove or quarter cove trims]

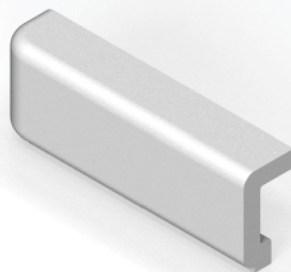

26BE4L 2"x 6" Box Cap extended bullnose stop - left [for use with surface trim only]



26BE4R 2"x 6" Box Cap extended bullnose stop - right [for use with surface trim only]

Cap Mouldings (continued)



26BE6L 2"x 6" Box Cap extended radius outside corner return - left [for use with radius bullnose or quarter round trims]



26BE6R 2"x 6" Box Cap extended radius outside corner return -right [for use with radius bullnose or quarter round trims]

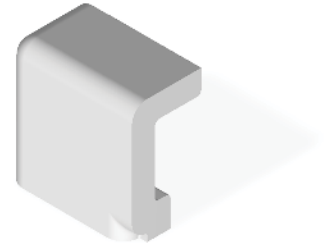

22BE07 2" x 2" Box Cap - outside corner [for transitioning wainscot up-corners or picture framing within tile field]





33VC07 3" x 3"
Victoria Cap Frame
Corner - inside



36VC00 3" X 6" Victoria Cap

33VC06 3" x 3"
Victoria Cap Frame
Corner - outside



36VC01 3" Victoria
Cap Outside Corner



36VC03 3" Victoria Cap
Inside Corner

36VC04 3" Victoria Cap
Inside Corner - Squared

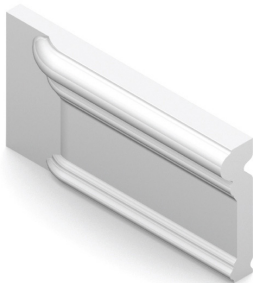

36VC2L 3" Victoria
Cap End Stop - left



36VC2R 3" Victoria
Cap End Stop - right

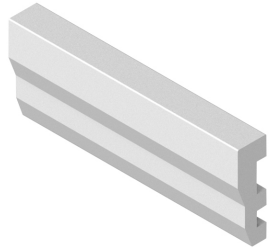

26BC00 2-3/8" X 6"
Beveled Cap Moulding



26BC01 2-3/8"
Beveled Cap Moulding
Outside Corner

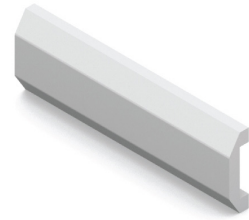

26BL00 2" x 6" Bevel liner

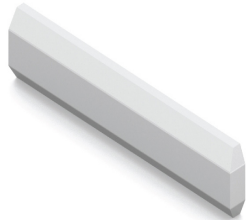

26BL01 2" x 6" Bevel
Liner - bevel outside
corner trim/ end stop



33BV00 3" x 3" Bevel
Field (sold in 3.5 sq ft
increments)

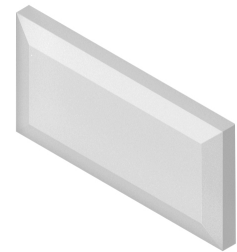

36BV00 3" x 6" Bevel
Field (sold in 3.5 sq ft
increments)



03BC00
3" Bevel Inside Corner
Cove



03BR00
3" Bevel Outside Corner
Round

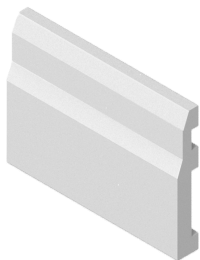

46BB00 4-3/8" x 6"
Beveled Base Moulding



46BB01 4-3/8" x 6"
Bevel
Base Moulding Outside
Corner
(for use with radius bullnose or
quarter round trims)



46BB02 4-3/8" x 6"
Bevel
Base moulding Inside
Corner
(for use with radius bullnose or
quarter cove trims)

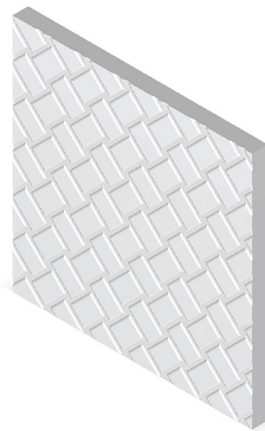

66BW00 6" x 6"
Basketweave Field /
Border



69BB00 6" x 9" Beadboard Tile



15QC01

Series 15 - Quarter Cove
Inside Corner - 3/4"-
radius



15QC03

Series 15 - Quarter Cove
Inside Corner - non-
radius

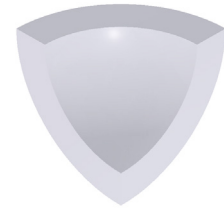

15QC04

Series 15 - Quarter Cove
Inside Corner - 3 way



15QR01

Series 15 - Quarter Round
Outside Corner



15QC02

Series 15 - Quarter Cove Inside
Corner



15QR02

Series 15 - Quarter Round
Outside Corner

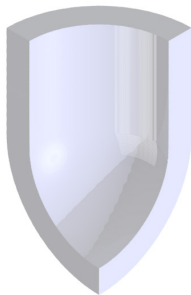

15QC13

Series 15 - 3" Quarter Cove
Beak Inside Corner - 3 way



15QR13

Series 15 - 3" Quarter
Round Beak Outside
Corner - 3 way

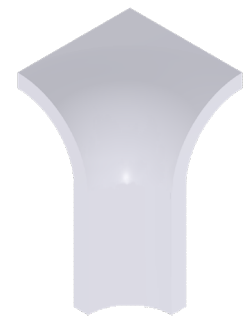

15QC23

Series 15 - 3" Corner Round
Inside Corner



15QR23

Series 15 - 3" Corner
Round Outside
Corner



15QC60

Series 15 - 6" Quarter
Cove



15QR60

Series 15 - 6" Quarter
Round

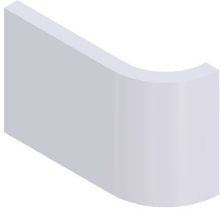

15RB33
Series 15 - 3" x 4-1/2"
Radius Bullnose

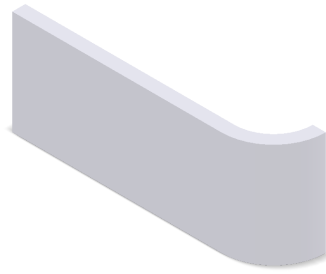

15RB63
Series 15 - 3" x 7-1/2"
Radius Bullnose

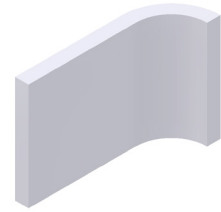

15RC33
Series 15 - 3" x 4-1/2"
Radius Cove



15RC63
Series 15 - 3" x
7-1/2" Radius
Cove



15PCIC
Series 15 - P-cap Inside
Corner



15PCOC
Series 15 - P-cap Outside
Corner



15BXIC
Series 15 - Box-cap Inside
Corner



15BXOC
Series 15 - Box-cap Outside
Corner

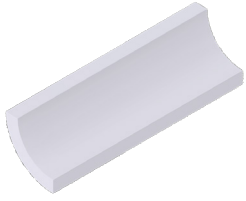

15QC00
Series 15 - 1.5" x 6" Ellis
Cove



15RC36
Series 15 - 3" x 6" Radius
Cove



15RC3C
Series 15 - 3" x 12" Radius
Cove



15QR00
Series 15 - 1.5" x 6" Mud
Cap



15RB36
Series 15 - 3" x 6" Radius
Bullnose



15RB3C
Series 15 - 3" x 12" Radius
Bullnose

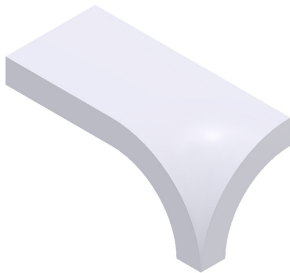

15SU13
Series 15 - 1-3/8" x 3"
Radius Down Corner -
right

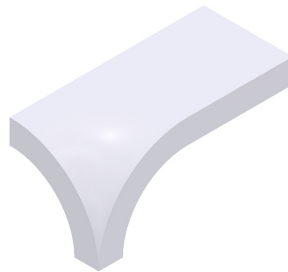

15SU31
Series 15 - 1-3/8" x 3"
Radius Down Corner -
left



33HD00 2-3/4" x
2-3/4" Hex Dome Field
Tile



33HX00 2-3/4" x
2-3/4" Hex Flat Field
Tile



33HX4P 2-3/4" x 2-3/4"
Hex Fkat Field Tile - 4-point
trim



33HX5P 2-3/4" x 2-3/4"
Hex Fkat Field Tile - 5-
point trim



44RT01 Sculptured
Tile - Diamond Pattern

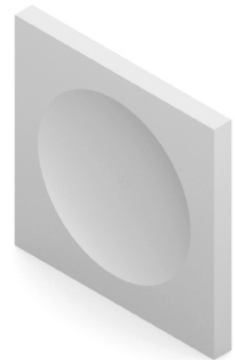

44RT02 Sculptured
Tile - Sphere Pattern

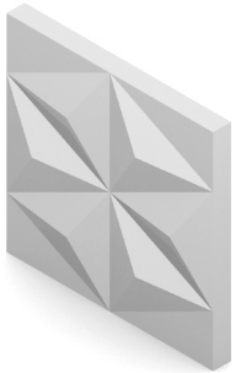

44RT03 Sculptured
Tile -Star Pattern

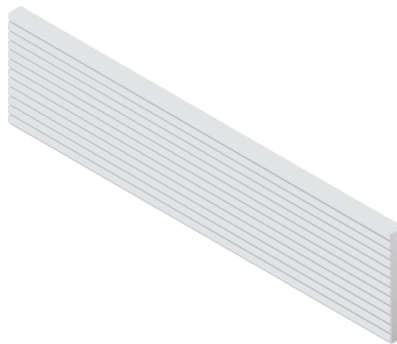

3CFTC2 3" x 12"
Corrugated Texture Field
Tile

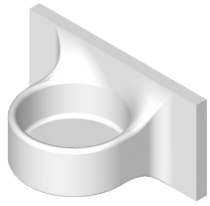

36CH00 3" x 6" Tile-in
Cup Holder

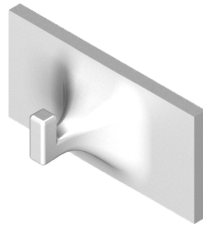

36RH00 3" x 6" Tile-in
Robe
Hook (protrudes 2-1/8" when
tiled-in)

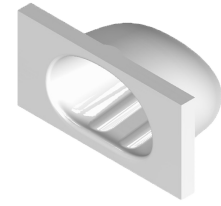

36SD00 3" x 6"
Recessed Soap
Dish (2-5/8" interior depth)

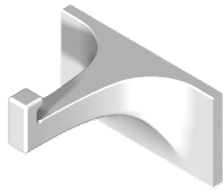

36SS00 3" x 6" Tile-in
Shelf
Support (buy two for pair)

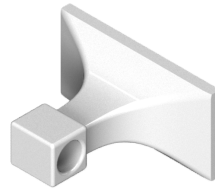

36TB00 3" x 6" Tile-in
Towel
Bar End (buy two for a pair)



44CH00 4-1/4" x
4-1/4" Tile-in Cup
Holder



44RH00 4-1/4" x 4-1/4" Tile-in Robe
Hook
(protrudes 4-3/8" when tiled-in)



44SD00 4-1/4" x 4-1/4" Soap Dish



44SS00 4-1/4" x 4-1/4" Shelf
Support
(buy two for a pair)

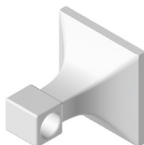

44TB00 4-1/4" x 4-1/4" Tile-in
Towel
Bar End (buy two for a pair)



66PH00 6" x 6" Recessed Paper Holder

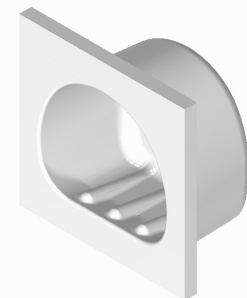

66SD00 6" x 6" Recessed
Soap Dish
(3" interior depth)



1C83OX 3.5" x 5"
Single Duplex Outlet
Cover Plate

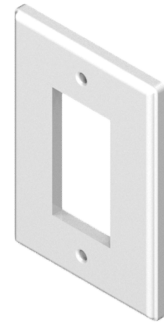

1C84RX 3.5" x 5"
Single GFI/ Rocker Switch
Cover Plate

1C82SX 3.5" x 5"
Single Standard Switch
Cover Plate

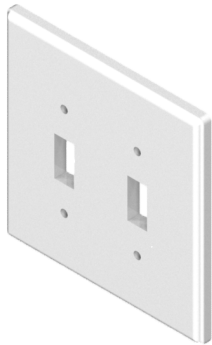

2C85SS 5" x 5"
Double Standard
Switch Cover Plate



2C86SO 5" x 5" Double
Switch/ Duplex Outlet
Cover Plate

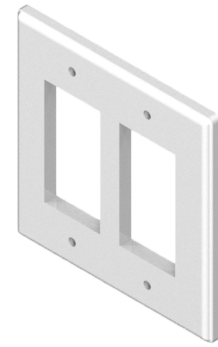

2C89RR 5" x 5" Double
GFI/ Rocker Switch Cover
Plate

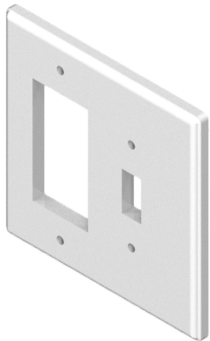

2C94SR 5" x 5" Double
Switch & GFI/ Rocker Switch
Cover Plate

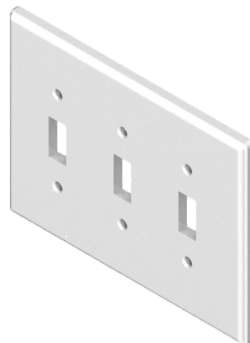

3C92SS 6-7/8" x 5" Triple
Switch Cover Plate

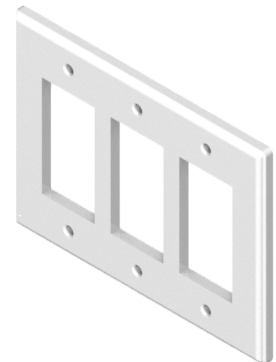

3C93RR 6-7/8" x 5" Triple GFI/
Rocker Switch Cover Plate